



THE UNITED REPUBLIC OF TANZANIA
 PRIME MINISTER'S OFFICE
 TANZANIA INVESTMENT CENTRE

FILE BEGINS

ENDS

PART

FILE TITLE

FILE NUMBER
TICC

CONFIDENTIAL

PP-101/
042558

INDEX HEADINGS

For Action F/M	Initials	Date	Action taken vide F/M	Officer or Section	For Action F/M	Initials	Date	Action taken vide F/M	Officer or Section	For Action F/M	Initials	Date	Action taken vide F/M
F1	JMK	28/10/13	[Signature]										
F1	R	31/10/13	[Signature]										
M1	G	15/11/13	[Signature]										
F1	SM	19/12/13	[Signature]										
F4	G	01/12/13	[Signature]										
M2	G	11/12/13	[Signature]										
F5	SM	24/1/14	[Signature]										
F5	G	24/1/14	[Signature]										

PP-101/042558

OASIS GREEN TANZANIA
LIMITED

MINUTE SHEET

Dokezo
No.

1.0

EXD

The approved project has fulfilled the investment requirements, which are: -

(a) Minimum finance investment threshold has been exceeded, the project expects to invest US\$ 2.528M

(b) Legal entity has been incorporated under certificate

No. 102647 of 23/09/2013

Based on the above, the letter of approval is hereby submitted for signature in order for the project to comply with the requirements of Section 17 of Tanzania Investment Act, 1997.

Submitted for signature.



N. Senzia
DIF

19th November, 2013



2.0

EXD

In response to the TIC letter of registration dated 19th September 2013

the project has submitted the required documents namely: -

(a) Company Board Resolution.

(b) Reference letter/Financing from FBME Bank Ltd

(c) Lease Agreement as evidence of land

With the above submission EXD is requested to sign Certificate of Incentives No. 042558 herein attached.



DIF

MINUTE SHEET

Dokezo
No.

THE COMPANIES ACT 2002

COMPANY LIMITED BY SHARES

**MEMORANDUM
AND**

ARTICLES OF ASSOCIATION

OF

OASIS GREEN TANZANIA LIMITED

Incorporated this

day of

2013

**DRAWN BY
MAHAMUD A. ALLY
(SUBSCRIBER)
P.O. BOX 65365
DAR ES SALAAM**

THE UNITED REPUBLIC OF TANZANIA



CERTIFICATE OF INCORPORATION

NO.

I HEREBY CERTIFY THAT

OASIS GREEN TANZANIA LIMITED

Is this day incorporated under the companies Act 2002 and
that the company is Limited

GIVEN under my hand at Dar es Salaam, day of
Two Thousand and Thirteen

Registrar of Companies

THE COMPANIES ACT NO. 12 OF 2002
COMPANY LIMITED BY SHARES
MEMORANDUM OF ASSOCIATION

OF

OASIS GREEN TANZANIA LIMITED

1. The name of the company "**OASIS GREEN TANZANIA LIMITED**"
2. The Registered office of the Company will be situated in Tanzania.
3. The objects for which the Company is established are:-
 - (a) To carry on the business of commissioner agents of all types of recycling of used Lubricant, petroleum products ranging from crude/black oil to white/refined products such as gas, paraffin, petrol, kerosene, engines oils, gas-oil/diesel, oils and other lubricants, grease bitumen, petrochemical etc. and petroleum by-products; by providing a business link between the producer/suppliers and the buyers/customers within the country and elsewhere in the World, thus to initiate and conclude business negotiations/deal on their behalf.
 - (b) To carry on the business of manufacturing lubricant oil, petroleum and petroleum products, storage, distributors, sale and use of crude/black oil, petroleum products in the country and export outside the country, oil depots, coal, coke, patent, fuel, oil of all kinds, manufacture of goods, mining of all kinds of minerals, promote oil distributors and open small oils shops, general traders, merchants suppliers of general goods, commission agents, manufacturers representatives and to buy, sell, hire, manufacture, barter trade and deal in property, spare parts and machinery of every descriptions, goods and services of general merchandise of all kinds of transact any and every manufacturing of petroleum, oil, fuel oil depots, oil extraction oil purification and sale the same, mercantile, insurance and financial business, general services of all kinds of goods and general merchandise.
 - (c) To carry on business of petrol station and deal in petrol, diesel, oil kerosene, mineral oil, crude oil, lubricating oil, grease and fuel oil of all kinds and all other kind of mineral and petroleum products as an importers, dealer or distributors and servicing and repairing of vehicles of all kinds.
 - (d) To carry on all or any of the business of Public transport, cargo handling, consultant, carriage and haulage contractors, stevedoring and lighterage, owners and charter of road vehicles, aircraft and ships and boats of every description and carriers of goods by road, rail, water or air and to establish, acquire, maintain and operate transport service of every

25005
38931 23/4
Asst. Secy of Companies

description both public and private and all services ancillary thereto and for such purposes or as independent undertakings to purchase, take in exchange, charter, hire, build, contract or otherwise acquire and to own, operate, work, manage, maintain, repair, service and deal with and in road vehicles, aircraft and vessels of every supplies therefore and to conduct any such business within the country or any other state in Africa or Europe or Asia and or any other foreign country.

- (e) To carry on the business of clearing and forwarding agents, logistic, commission agents, transporters, freighters, hauliers, customs bonded warehouse and godown keepers, cargo and travel agents, insurance agents, tourist agents, manufacturers' representatives, road contractors, cargo superintendents, packers, machinery haulage specialists, warehousemen, engineers, electricians, motor cars, trucks, cabs, omnibus, oil tank and coach proprietors and transporters, civil transport contractors and transporters by any other means of conveyance of people and goods in Tanzania and the neighbouring countries and in such other place or places as may from time to time be determined by the company, engage in and or otherwise carry on the business as transporters and transport agents, freight forwarders.
- (f) To purchase or otherwise acquire aircrafts, ships and boats and to carry on the business of air chattering, air training, air lifting cargo and freight, schedule air services, sea charters, aviation managers, aviation consultants and tour operators.
- (g) To construct, equip, maintain works purchase and let or hire aero-planes for the carriage of passengers or freight and to carry on the business of carriers by air.
- (h) To carry on business of travel agency; car hire and safaris tours operators, ticket bookings, garage, buying and selling motor vehicles, transport agents, transportation of goods, and passengers by air, sea, land, import and export, gift shops, boutiques, entertainment and all artist work, safari outfitters, safari contractors, and guides, for hunting trophy dealers, travel and tourist and other travelers by way of promoting and facilitating conveniences of all kinds such as reserved places, baggage deposit, courier services, sleeping card enquiry bureau, hotel and lodging accommodation, guides, motor vehicles hire, airplane and motor boats character and otherwise facilitating tourist movements and accommodation, photographic safaris lodges and hotel, tourism and all related business and to promote tourism in Tanzania and elsewhere all over the world.
- (i) To be general traders, suppliers, merchants, importers, exporters, stockists, wholesalers, retailers and dealers in building materials, all types of new and second hand spare parts and accessories and general to deal in all types of motor spare parts and industrial spare parts, auto service, hardware, building materials, maintenance, tyres, tubes, tools and accessories for all types of automotive, motor vehicles, agricultural

machinery, implements, equipment, all kinds of industrial projects machinery and equipment, electrical goods, timber, fishing gears, groceries, computers, office furniture's and equipments, cooking oils, salts, foodstuffs, cosmetics, oils, paints, spirits sheets, hinges, screws, iron mongery, textiles piece goods, all types of leather goods, shoes, bags and other similar goods.

- (j) To carry on the business of garage proprietors and service station for motor vehicles of all kinds, to carry on the safe keeping, cleaning, repairing, refueling, panel beating, spraying and the general care of motor vehicles, aircraft, machinery, equipment and plant whether moved by mechanical power or not, implements, utensils, appliances, apparatus, fuel for internal combustion engines, lubricants, cements, solutions, batteries and accessories and all things capable of being used in connection with the said businesses or in the manufacture or maintenance of such vehicles, machinery, equipment and plant.
- (k) To carry on the business of sanitation, sewerage works, solid waste management and any other activity related thereof. To carry out in environmental ports activities.
- (l) To carry on the business of supplying of stationery, office equipment, writing materials, teaching aids and other educational establishment and as agents, school uniforms and stationers in all their business and to buy and sell stationery, office requirements and equipment, all types of books, sundry goods and to act as general merchants and commission agents of print and bind and manufacture stationers and other requirements.
- (m) To carry on the business of service station for motor vehicles of all kinds, to carry on the sake keeping, cleaning repairing, refueling, panel, beating, spraying and the general care of moor vehicles, tools, equipment, fuel for internal combustion engines, lubricants, solutions, batteries and accessories and all thing capable of being used in connection with the said business of in the manufacturing or maintenance of such vehicles, machinery, equipment and plant.
- (n) To search for ores, minerals and hydrocarbons and to apply licenses for mining, prospecting, drilling is or over many land which maybe acquired by the company and to lease and such kinds for building or for agricultural use and to sell or otherwise dispose the lands, miner of all kinds of minerals, and or other property of the company excavate and extract and submit to any refinement process of manufacture, to prepare for market and generally deal in prospering mining, smelting and refining, deal in diamonds, gold, silver and all kinds of minerals, petrol and petroleum products.
- (o) To engage in and carry out the business of proprietors and managers of hotels, restaurants, cafes, road houses, motels, lodges marquees, hotel management, safari and holiday camps, caravan sites, guest houses, apartment housekeepers, refreshment and tea rooms, milk and snacks

bars, tavern, beer house and lodging housekeepers and to provide food and catering services to individuals, private and public institutions and to industrial and business concerns, also to provide variety of services and products to guest, tourist and hoteliers related to activities of marine parks and reserves along the coast and any other place, trade or business of hotel keepers, restaurant, café, food processing, nyama choma zones, road house auto-court, motel, holiday camp, cottages/tenting area, manage construction and mining camps, and manage the above on behalf of others, caravan sites, guest houses, refreshment and tea rooms, milk and snack bar, tavern, beer house to provide food and catering services to individuals private and public institutions and to industrial and business concerns, mining area and air and sea catering, caterers proprietors of places of recreation and amusement, beach resort, sport and amusement including discotheque and all businesses and trades incidental to or similar thereto or required to be or capable of being carried on in conjunction therewith;

- (p) To engage in and carry out the business of proprietors and managers of hotels, restaurants, cafes, road houses, motels, lodges marquees, hotel management, safari and holiday camps, caravan sites, guest houses, apartment housekeepers, refreshment and tea rooms, milk and snacks bars, tavern, beer house and lodging housekeepers and to provide food and catering services to individuals, private and public institutions and to industrial and business concerns, also to provide variety of services and products to guest, tourist and hoteliers related to activities of marine parks and reserves along the coast and any other place.
- (q) To invest, own, manage, engaged and carryout the business of selling books, stationery products, documents and publications; manufacturers and marketers of paper and paper products, newspapers, and magazines, newsletters, cardboards, envelopes and other similar products and materials.
- (r) To carry and promote and trade or business of farm and agricultural inputs, implements, tools, packaging materials and deal in the livestock and or the veterinary health care products to farmers and stockists to buy, sell, supply, distribute whether in retail or wholesale fertilizer, insecticides, fungicides, growth stimulants, agro seeds, farm implements and tools, animals feeds, veterinary drugs and any related goods and import agricultural and food technology, industries and equipment, manufacture and semi processed products in Tanzania and other parts of the world.
- (s) To carry on the business as importers, exporters, general traders, suppliers, merchants, stockists, wholesalers, retailers and dealers in all types of spare parts and maintenance, tyres, tubes, tools and accessories for all types of automotive, motor vehicles, agricultural machinery, implements, equipment, all kinds of industrial projects machinery and equipment, electrical goods, hardware, building materials, timber, fishing gears, groceries, computers, office equipments, cooking oils, salts,

foodstuffs, cosmetics, oils, paints, spirits sheets, hinges, screws, iron mongery, textiles piece goods, all types of leather goods, shoes, bags and other similar goods.

To carry on the business as principals, agents or manufacturers, representatives of importing, exporting, buying, selling, distributing of motor vehicles, cars, trucks, lorries or other vehicles, motor vehicles spares and parts of all descriptions, fuel and other oils, petroleum of all kinds, tyres and tubes, batteries, battery solution and other spares, accessories, motor cycles, bicycles, tractors, mining equipments, fishing gears, agricultural and industrial machinery and equipments, new and second hand spare parts and accessories and generally to deal in all types of motor spare parts and industrial and agricultural machinery and parts, electronic goods and accessories thereof.

(u) To manufacture, buy, sell, exchange, alter, improve, manipulate, prepare for market and otherwise deal in all kinds of plant, machinery, apparatus, tools, utensils, hardware and other substances, materials, and things whatsoever.

(v) To carry on the business of fumigators, vacuum cleaners, steam cleaners, carpet cleaners, window shop, officer, club hotel, theatre cleaners vermin and insects destroyers and generally to undertake cleaning and fumigation of any kind.

(w) To carry out the business of media and entertainment advertising, media communication and consultancy advertising agents, public relations consultants and sale promotion consultants in all their aspects and to advise on publicity, sales promotion, staff relations, industrial relation, press and community relations. To conduct and advise on market research, publicity projects, advertising campaigns, exhibitions, trade affairs, displays, film shows, radio and television programmes, and also to carry on the business of investment advisers, market research and to act as intermediaries in the introduction of sellers, purchasers and partners.

(x) To engage in manufacturing of every kind of item, furniture, textiles blankets, boutiques, indulge in tailoring, knitting, sisal and coconut fibre processing, ropes, twine, carving, handcrafts, to buy, sell and import the same.

(y) To carry on the business of household, domestic appliance and electrical goods, audio visual goods, electronic items, building material, hardwares, foodstuff, agricultural products and merchandise of every nature, kind and description whatsoever as a dealer, wholesaler, retailer, distributor, importer, exporter and after sales service and repairing.

(z) To carry on the business of electrical as contractors, electrical and mechanical engineers and manufacturers, workers and dealers in electrical apparatus and goods and the manufacture or hire of apparatus

or goods to which the application of electricity or and kind of power, or any power that can be used as a substitute therefore, is or may be useful convenient or ornamental, or any other business of a like nature.

- (aa) To engage in and carry out the business of proprietors and managers of hotels, restaurants, cafes, road houses, motels, safari and holiday camps, caravan sites, guest houses, apartment housekeepers, refreshment and tea rooms, milk and snacks bars, tavern, beer house and lodging housekeepers and to provide food and catering services to individuals, private and public institutions and to industrial and business concerns.
- (bb) To carry on the business of sanitation, sewerage works, solid waste management and any other activity related thereof.
- (cc) To carry on the business of production of audiovisual material, information, advertising, documentary and art films, for television, cinema, education or commercial purposes, archives, NGO's or other industries, or for any other purpose whatsoever.
- (dd) To promote tourism in Tanzania and elsewhere in Africa, to carry on business of travel and tourist agents and tour operators, to promote facilitate travelling to organise hunting, tented-camps, fishing and diving expeditions, safari promoters and undertakers generally and in particular to arrange and manager hunting safaris, photo safaris adventure tours, fishing trips, handling of game trophies and animal skins, catching, harbouring, transporting, wildlife and marine products of all kind.
- (ee) To purchase, take on lease and otherwise acquire for investment or resale any estate, land, buildings, easements and other rights and interests in immovable property or any tenure in Tanzania and elsewhere and to sell let or lease exchange or otherwise dispose of or grant rights over any immovable property, belong to the company.
- (ff) To purchase, take or lease or in exchange, hire or otherwise acquire and hold any state or interest in any lands buildings, casements, rights, licenses secret processes, machinery, plants, stock, in trade and real or personal property of any kind.
- (gg) To accept payment for any property or rights sold or otherwise disposed or dealt with by the company either in cash, by installment or otherwise or in fully or partly paid up shares of the company or corporation, with or without deferred or preferred or guaranteed rights.
- (hh) To carry any other trade or business whatever which can in the opinion of the Board of Directors be advantageously carried on by the Company in connection with the above business or the general business of the company.
- (ii) To act as agents for the sale and purchase of any stocks shares or securities or for any other monetary or mercantile transactions.

- (jj) To act as executors and trustees of wills and settlements made by customers and others and undertake and execute trusts of all kinds.
- (kk) To do all or any of the above things in any part of the world and either as principals, agents, trustees, contractors or otherwise, and either alone or in conjunction with others and either or through agents, sub-contractors, trustees and otherwise.
- (ll) To remunerate any person, firm or company rendering services to this company, whether by cash payments or by allotment to him or them of shares or securities of the Company credited and paid in full or in part, otherwise.
- (mm) To accept for safe custody and keep for customers of the company all kinds of securities valuables and things.
- (nn) To lend money on any terms that may thought fit, and particularly to customers or other person or corporations having dealing with societies and to give any guarantees that may be expedient.
- (oo) To advance money to shareholders in the company, and other to the purpose of enabling the person borrowing the same erect or purchase, or enlarge or repair any house or building or to purchase the fee simple or any less estate or interest in, or to take a demise for any term or terms of years of any freehold or leasehold property upon such terms and conditions as the company may think fit.
- (pp) To invest and deal with the moneys of the Company not immediately required, upon such securities and in such manner as may from time to time be determined.
- (qq) To distribute among the members in pieces any property of the company, or any proceeds of sale or disposal of any property of the company.
- (rr) To draw, make, accept, endorse, discount execute and issue promissory notes, bills of lading, warrants, debentures and negotiable or transferable instruments.
- (ss) To act as agents or brokers, and as trustees for any person firm or company, and to undertake and perform sub-contracts and also to act in any other business of the company through or by means of agents, brokers, sub-contractors or others.
- (tt) To obtain any provisional order, ordinance or act of Parliament for enabling the Company to carry any of it is objects into effect, or for affecting any modification of the Company's constitution, or any other purpose which may seem expedient, and to oppose any proceedings or

applications which may seem calculated, directly or indirectly to prejudice the company's interest.

- (uu) To take or otherwise and hold shares in any other company having objects altogether or in part similar to this company, or carrying on any business capable of being conducted so as directly or indirectly to benefit the company.
- (vv) To transact or carry on all kinds of Agency business and in particular in relation to the investment of money, the sale of property, and the collection and receipt of money.
- (ww) To do all other things as may be deemed incidental or conducive to the entertainment of the objects or any of them.

And it is hereby declared that:-





The word "company" in this clause, except where used in reference to this Company, shall be deemed to include any partnership or other body of persons, whether corporate or incorporate, and whether domiciled in the United Republic of Tanzania or elsewhere.

The object specified in each of the paragraphs of the paragraph of this clause shall be regarded as independent objects, and accordingly shall in no way be limited or restricted (except where otherwise expressed in such paragraphs) by reference to or inference from the terms of any other paragraph of the name of the Company but may be carried out in as full and ample a manner and construed in as wide a sense as if each of the said paragraph define the objects of the separate and distinct compound.

That the meaning of any general word or words in any paragraph of this clause shall not be restricted by being construed ejusdem generis with any particular word or words in the same paragraph.

4. The Liability of the Members is Limited.
5. The capital of the Company is Shillings 800,000,000/= divided into 10,000 shares of Shillings 80,000/= each. The Company shall have powers to increase its capital and to divide the shares in its capital for the time being into several classes of stock or shares and to attach thereto respectively such preferential, deferred or special rights, privileges, or conditions as may be determined by or in accordance with the Articles of Association of the Company.

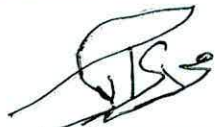
We, the several persons whose names and addresses are subscribed, are desirous of being formed into a company, in pursuance of this Memorandum of Association, and we respectively agree to take the number of shares in the capital of the Company set opposite our respective names.

Names, Addresses, and Description of Subscribers.	Number of shares taken by each Subscriber	Signature
MAHAMUD AHMED ALLI P. O. BOX 65265 DAR ES SALAAM	2500	
FAYROUZ KHAN P. O. BOX 65265 DAR ES SALAAM	2000	
DR. ABDUL AZIZ DAKHEEL FAHAD P. O. BOX 65265 DAR ES SALAAM	2000	
MARWAN ABOURAS P. O. BOX 65265 DAR ES SALAAM	2000	
FAYAZ KHAN P. O. BOX 65265 DAR ES SALAAM	1500	

Dated at Dar es Salaam this 23 day of SEPT 2013

Witness to the above signatures

Name :

Signature :

Postal Address :

Qualification :



500006
28031 28/9/13

THE COMPANIES ACT NO. 12 OF 2002
PRIVATE COMPANY LIMITED BY SHARES

ARTICLES OF ASSOCIATION

OASIS GREEN TANZANIA LIMITED

TANZANIA
Stamp Duty Paid 280006
Receipt No. 38031 28/9
#

1. In these articles:-

"the Act" means the Companies Act;

"the articles" means the act of the company;

"clear days" in relation to the period of a notice means that period excluding the day when the notice is given or deemed to be given and the day for which it is given or on which it is to take effect;

"the seal" means any person appointed to perform the duties of the secretary of the company;

"Secretary" shall mean any person appointed to perform the duties of Secretary of the Company;

Expressions referring to writing shall, unless the contrary intention appears, be construed as including references to printing, lithography, photograph, and other modes of representing or reproducing words in a visible form.

Unless the context otherwise requires, words or expressions contained in these articles shall bear the same meaning as in the Act or any statutory modification thereof in force at the date at which these articles become binding on the company.

MEMBERS

- 2. The number of members with which the company proposes to be registered is but the directors may from time to time register an increase of members.
- 3. The subscribers to the memorandum of association and such other persons as the directors shall admit to membership shall be members of the company.

GENERAL MEETINGS

- 4. The Company shall in each year hold a general meeting as its annual general meeting in addition to any other meetings in that year, and shall specify the meeting as such in the notice calling it; and not more

than fifteen months shall elapse between the date of one annual general meeting of the company and that of the next.

Provided that so long as the company holds its first annual general meeting within eighteen months of its incorporation, it need not hold it in the year of its incorporation or in the following year. The annual general meeting shall be held at such time and place, as the directors shall appoint.

5. All general meetings other than annual general meetings shall be called extraordinary general meetings.
6. The directors may, whenever they think fit, convene an extraordinary general meeting, and extraordinary general meetings shall also be convened on such requisition, or in default, may be convened by such requisitionists, as provided by section 133 of the Act. If at any time there are not within the Tanzania sufficient directors capable of acting to form a quorum, any director or any two members of the company may convene an extraordinary general meeting in the same manner as nearly as possible as that in which meeting may be convened by the directors.

NOTICE OF GENERAL MEETINGS

7. Every general meeting shall be called by twenty-one clear days' notice in writing at the least. The notice shall specify the place, the day and hour of meeting and, in case of special business, the general nature of that business:

Provided that a meeting of the company shall, notwithstanding that it is called by shorter notice than that specified in this article be deemed to have been duly called if it so agreed:-

- (a) in the case of a meeting called as the annual general meeting, by all the members entitled to attend and vote thereat; and
 - (b) in the case of any other meeting, by a majority in number of the members having a right to attend and vote at the meeting, being a majority together representation not less than ninety – five percent of the total voting rights at that meeting of all the members.
8. Subject to the provisions of the articles, the notice shall be given to all the members, to all persons entitled to a share in consequence of the death or bankruptcy of a member and to the directors and auditors. The accidental omission to give notice of a meeting to, or the non receipt to notice of a meeting by, any person entitled to receive notice shall not invalidate the proceedings at that meeting.

PROCEEDINGS AT GENERAL MEETINGS

9. All business shall be deemed special that is transacted at an extraordinary general meeting, and also all that is transacted at an annual general meeting, with the exception of declaring a dividend, the consideration of the accounts, balance sheets, and the reports of the directors and auditors, the election in the place of those retiring and the appointment of, and the fixing of the remuneration of the auditors.
10. No business shall be transacted at any general meeting unless a quorum of members is present at the time when the meeting proceeds to business; two persons, entitled to vote on the business to be transacted, each being a member or a proxy for a member or a duly authorized representative of a corporation, shall be a quorum.
11. If within half an hour from the time appointed for the meeting quorum is not present, or if during the course of a meeting a quorum is not present, the meeting shall stand adjourned to the same day in the next week, at the same time and place, or to such other day and at such other time and place as the directors may determine.
12. The Chairman, if any, of the board of directors or in his absence some other director nominated by the directors shall preside as chairman of the general meeting, but if neither the chairman nor such other director (if any) be present within fifteen minutes after the time appointed for the holding of the meeting and willing to act, the directors present shall elect one of their number to be chairman of the meeting and, if there is only one director and willing to act, he shall be chairman.
13. If at any meeting no director is willing to act as chairman or if no director is present within fifteen minutes after the time appointed for holding the meeting, the members present shall choose one of their number to be a chairman of the meeting.
14. The Chairman may, with the consent of any meeting at which a quorum is present (and shall if so directed by the meeting), adjourn the meeting from time to time and from place to place, but no business shall be transacted at any adjourned meeting other than the business which might properly have been transacted at the meeting had the adjournment not taken place. When a meeting is adjourned for fourteen days or more, at least seven clear days notice of the adjourned meeting shall be given specifying the time and place of the meeting and the general nature of the business to be transacted. Save as aforesaid it shall not be necessary to give any notice of an adjournment or of the business to be transacted at an adjourned meeting.

15. At any general meeting a resolution put to the vote of the meeting shall be decided on a show of hands unless a poll is (before or on the declaration of the result of the show of hands demand:-
- (a) by the chairman; or
 - (b) by at least (three) members present in person or by proxy; or
 - (c) by any member or members present in person or by proxy and representing not less than one – tenth of the total voting rights of all the members having the right to vote at the meeting.

Unless a poll be so demanded a declaration by the chairman that a resolution has on a show of hands been carried or carried unanimously, or by a particular majority, or lost and an entry to the effect in the book containing the minutes of proceedings of the company shall be conclusive evidence of the fact without proof of the number or proportion of the votes recorded in favour of or against such resolution.

The demand for a poll may, before the poll is taken, be withdrawn

16. Except as provided in article 18, if a poll is duly demand it shall be taken in such manner as the chairman directs, and the result of the poll shall be deemed to be the resolution of the meeting at which the poll was demand.
17. In the case of an equality of votes, whether on a shoe of hands or on a poll, the chairman of the meeting shall be entitled to a second or casting vote.
18. A poll demanded on the election of a chairman, or on a question of adjournment, shall be taken immediately. A poll demanded on any other question shall be taken either immediately or at such time as the chairman of the meeting directs, and any business other than upon which a poll has been demanded may be proceeded with pending the taking of the poll.
19. A resolution in writing executed by or on behalf of each member who would have been entitled to vote upon it if it had been proposed at a general meeting at which he was present shall have effect as if it had been passed at a general meeting duly convened and held, and consist of several instruments in the like form each executed by or on behalf of one or more member.

VOTE OF MEMBERS

20. Every member shall have one vote.
21. A member in respect of whose estate a manager has been appointed under section 26 of the Mental Diseases Ordinance, may vote, whether

on a show of hands or on a poll, by his said manager, and any such manager may, on a poll, vote by proxy.

22. No member shall be entitled to vote at any general meeting unless all moneys presently payable by him to the company have been paid.
23. On a poll votes may be given either personally or by proxy.
24. The instrument appointing a proxy shall be in writing under the hand of the appointer or of his attorney duly authorized in writing, or, if the appointer is a corporation, either under sea) or under the hand of an officer or attorney duly authorized. A proxy need not be a member of the company.
25. The instrument appointing a proxy and the power of attorney or other authority, if any, under which it is signed or a notarially certified copy of that power or authority shall be deposited at the registered office of the company or at such other place within the Territory as is specified for that purpose in the notice convening the meeting, not less than 48 hours before the time for holding the meeting of adjourned meeting at which the per son named in the instrument proposes to vote, or, in the case of a poll, not less than 24 hours before the time appointed for the taking of the poll, and in default the instrument of proxy shall not be treated as valid.
26. An instrument appointing a proxy shall be in the following form or a form as near hereto as circumstances admit:-

" Limited
I/We of, being a member/
members
of the above – named company, hereby appoint
, of
or failing him of, as my/our
proxy to vote for
me/us on my/or behalf at the {annual or extraordinary, as the case
maybe} general meeting of the
company to be held on theday of200.....,
and at any adjournment thereof.
Signed this day of,200"

27. Where it is desired to afford members an opportunity of voting for or against a resolution the instrument appointing a proxy shall be in the following form or a form as near thereto as circumstances admit:-

"Limited.
I/Weof Being a member/members of
the above named company, hereby appoint of of
..... or failing
him of, as my/our proxy to vote for me/us on
my/our behalf at the {annual or extraordinary, as the case may

be}general meeting of the company to be held on theday
of.....200....., and at any adjournment thereof.
Signed thisday of.....200

This form is to be used* in favour of/against the resolution. Unless
otherwise instructed, the proxy will vote as he thinks fit.

*Strike out which ever is not desire"

28. The instrument appointing a proxy shall be deemed to confer authority
to demand or join in demanding a poll.
29. A vote given in accordance with the terms of an instrument of proxy, or
poll demanded by proxy, or by the duty authorized representative of a
corporation shall be valid notwithstanding the previous determination of
the authority of the person voting or demanding a poll unless notice of
the determination was received by the company at its registered office
(or at such other place at which the instrument of proxy was duly
deposited) before the commencement of the meeting or adjourned
meeting at which the proxy is used.

CORPORATIONS ACTING BY REPRESENTATION AT MEETINGS

30. Any corporation which is a member of the company may be resolution
of its directors or other governing body authorize such person as it
thinks fit to act as its representative at any meeting of the company,
and the person so authorized shall be entitled to exercise the same
powers on behalf of the corporation which he represents as that
corporation could exercise if it were an individual member of the
company.

DIRECTORS

31. The Number of the directors and the names of the first directors shall
be determined in writing by the subscribers of the memorandum of
association or a majority of them and until such determination the
signatories to the Memorandum of Association shall be the first
directors. Unless otherwise determined by ordinary resolution, the
number of directors shall not be subject to any maximum but shall be
not less than two.

- 1. MAHAMOUD AHMED ALLY**
- 2. FAYROUZ KHAN**
- 3. DR. ABDUL DAKHEEL FAHAD**
- 4. MARWAN ABOURAS**
- 5. FAYAZ KHAN**

32. The remuneration of the directors shall from time to time be
determined by the Company in general meeting. Such remuneration
shall be deemed to accrue from day to day. The directors shall also be
paid all traveling, hotel and other expenses properly incurred by them
in attending and returning from meetings of the directors or any

committee of the directors or general meetings of the company or in connection with the business of the company.

BORROWING POWERS

33. The director may exercise all the powers of the company to borrow money, and to mortgage or charge its undertaking and property, or any part thereof, and to issue debentures, debenture stock and other securities, whether outright or as security for any debt, liability or obligation of the company or any third party.

POWERS AND DUTIES OF DIRECTORS

34. Subject to the provisions of the Act, the memorandum and the articles and to any directions given by special resolution, the directors, who may exercise all the powers of the company, shall manage the business of the company. No alteration of the memorandum or articles and no such directions shall invalidate any prior act of the directors, which would otherwise have been valid. The powers given by this article shall not be limited by any special power given to the directors by the articles and a meeting of directors at which a quorum is present may exercise all powers exercisable by the directors.
35. The directors may by power of attorney appoint any person to be the attorney or agent of the company for such purposes and on such conditions as they determine, including authority for the attorney or agent to delegate all or any of his powers.
36. All cheques, promissory notes, drafts, bills of exchange and other negotiable instruments, and all receipts for moneys paid to the company, shall be signed, drawn, accepted, endorsed, or otherwise executed, as they case may be, in such manner as the directors shall from time to time by resolution determine,
37. The directors shall cause minutes to be made in books provided for the purpose:-
- (a) of all appointments of officers made by the directors;
 - (b) of the names of the directors present at each meeting of the directors and of any committees of the directors;
 - (c) of all resolutions and proceedings at all meetings of the company, and of the directors, and of committees of directors.

DISQUALIFICATION OF DIRECTORS

38. The office of director shall be vacated if the directors:-

- (a) Without the consent of the company in general meeting holds any other office of profit under the company; or
- (b) Becomes bankrupt or makes any arrangement or composition with his creditors generally; or
- (c) Cases to be a director by virtue of any provision of the Act or becomes prohibited by law from being a director; or

A director shall not vote in respect of any contract in which he is interested or any matter arising thereat, and if he does so vote shall not be counted.

- 39. The company may by ordinary resolution appoint a person who is willing to act as director to fill a vacancy or be an additional director.
- 40. The directors may appoint a person who is to act to be a director, either to fill a vacancy or as an additional director, but so that the total number of directors shall not at anytime exceed the number fixed by or in accordance with these articles. Any director so appointed shall hold office only until the next following annual general meeting, and shall then be eligible for re – election.
- 41. The company may by ordinary resolution, of which special notice had been given in accordance with section 144 of the Act, remove any director before the expiration of his period of office notwithstanding anything in the article or any agreement between the company and such director. Such removal shall be without prejudice to any claim such director may have for damages for breach of any contract of service between him and the company.
- 42. The company may by ordinary resolution appoint another person in place of a director removed from office under the immediately preceding article. Without prejudice to the powers of the directors under article 40 the company in general meeting may appoint any person to be a director either to fill a vacancy or as an additional director.
- 43. Subject to the provisions of the articles, the directors may regulate their meetings as they think fit. Questions arising at a meeting shall be decided by a majority of votes. In case of an equality of votes, the chairman shall have a second or casting vote. A director may, and the secretary at the request of a director shall, call a meeting of the directors. It shall not be necessary to give notice of a meeting of directors to any directors who are absent from Tanzania.
- 44. The quorum necessary for the directors may fix the transaction of the business of the directions, and unless so fixed shall be two.
- 45. The continuing directors may act notwithstanding any vacancy but, if and so long as their number is reduced below the number fixed by or pursuant to the articles of the act for the purpose of increasing the

number of directors to that number, or summoning a general meeting of the company, but for no other purpose.

46. The directors may appoint one of their numbers to be the chairman of the board of directors and determine the period of which he is to hold office. Unless he is unwilling to do so, the director so appointed shall preside at every meeting of directors at which he is present. But if no such chairman is appointed, or if he is unwilling to preside, or if at any meeting the chairman is not present within five minutes after the time appointed for holding the same, the directors present may choose one of their number to be chairman of the meeting.
47. The directors may delegate any of their powers to any committee consisting of one or more directors; any committees so formed shall in the exercise of the powers so to any such regulations, the proceedings of a committee with two or more members shall be governed by the articles regulating the proceedings of directors so far as they are capable of applying.
48. All act done by a meeting of the directors or of a committee of directors or by a person acting as a director shall, notwithstanding that it be afterwards discovered that there was some defect in the appointment of any such director, or that any of them were disqualified from holding office, or had vacated office, or were not entitled to vote, be as valid as if every such person had been duly appointed and was qualified and had continued to be a director and was entitled to vote.
49. A resolution in writing signed by all the directors entitled to receive notice of a meeting of the directors, or of a committee of directors, shall be as valid and effectual as if it had been passed at a meeting of the directors or {as the case may be} a committee of directors duly convened and held, and may consist of several documents in the like form each signed by one or more directors.

SECRETARY

50. The Secretary shall be appointed by the directors for such term, at such remuneration and upon such conditions as they may think fit; and any secretary so appointed may be removed by them.
51. A provisions of the Act or these articles requiring or authorizing a thing to be done by or to a director and the secretary shall not be satisfied by its being done by or to the same person acting both as director and as, or in place of, the secretary.

THE SEAL

52. The seal shall only be used by the authority of the directors or of a committee of the directors authorized by the directors. The directors may determine who shall sign any instrument to which the seal is

affixed and unless otherwise so determined it shall be signed by a director and by the secretary or by a second director.

53. The directors shall cause proper books of account to be kept with respect to:-
- (a) all sums of money received and expended by the company and the matters in respect to which the receipt and expenditure takes place;
 - (b) all sales and purchase of goods by the company; and
 - (c) the assets and liabilities of the company.





Property books shall not be deemed to be kept if there are not kept such books of account as are necessary to give a true and air view of the state of the company's affairs and to explain its transactions.

54. The books of account shall be kept at the registered officer of the company, or subject to section 151 (4) of the Act, at such other place or places as the directors think fit, and shall always be open to the inspection of the directors.
55. No number shall (as such) have right of inspecting any accounting records or other book or document of the company except as conferred by statue or authorized by the directories or by ordinary resolution of the company.
56. The directors shall from time to time in accordance with sections 153,155 and 150 of the Act, cause to be prepared and to be laid before the company in general meeting, such profit and loss accounts, balance sheets, group accounts (if any) and reports as are referred to in those sections.
57. In accordance with section 164 of the Act, the copy of the company's annual accounts to be laid before the company in general meeting

AUDIT

58. Auditors shall be appointed and their duties regulated in accordance with sections 170 to 179 of the Act.

59. Any notice to be given to or by any person pursuant to the act shall be in writing except that a notice calling a meeting of directors need not be in writing. The company may give any notice to a member either personally or by sending it by post in a prepared envelope addressed to the member at his registered address, or by leaving it at that address. Where a notice is sent by post, service of the notice shall be deemed to be effected by properly addressing, prepaying, and posting a letter containing the notice, and to have been effected at the expiration of seventy two hours after the letter containing the same was posted. A member whose registered address is not within the Tanzania and who gives to the company an address within the Tanzania at which notices may be given him shall be entitled to have notices given to him at that address, but otherwise no such member shall be entitled to receive any notice from the company.

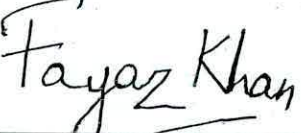
Names, Addresses, and Description of Subscribers.	Number of shares taken by each Subscriber	Signature
MAHAMUD AHMED ALLI P. O. BOX 65365 DAR ES SALAAM	2500	
FAYROUZ KHAN P. O. BOX 65365 DAR ES SALAAM	2000	
DR. ABDUL AZIZ DAKHEEL FAHAD P. O. BOX 65365 DAR ES SALAAM	2000	
MARWAN ABOURAS P. O. BOX 65365 DAR ES SALAAM	2000	
FAYAZ KHAN P. O. BOX 65365 DAR ES SALAAM	1500	

Date at Arifi this 23 day of SEPT 2013

Witness to the above signatures

Name :
Signature :
Postal Address :
Qualification :





FBME BANK LTD

Ref: 255/2013/Am/am

Date: 3rd Oct, 2013

**Executive Director,
Tanzania Investment Centre,
P.o.Box 938,
Dar es Salaam.**

Dear Sir/Madam,

RE: CERTIFICATE OF REFERENCE OF MR. MAHAMOUD AHMED ALLY.

We certify that **Mr. Mahamoud Ahmed Ally** is our customer maintaining Current Account bearing number **010994** with our Bank for past eight years and the conduct of his account has been well satisfactory.

This certificate is being issued as per request of **Mr. Mahamoud Ahmed Ally** without any responsibility or engagement, whatsoever, on the part of the Bank or any of its officials.

Thanking you.

Yours faithfully,

Abia N. Maneno.
Assistant Operations Manager

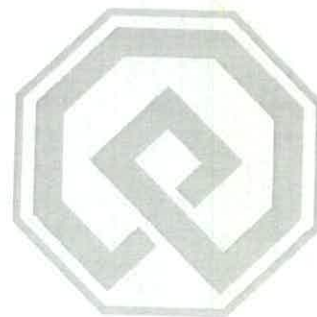

FBME BANK

TANZANIA



Certificate of Incorporation

Section 15

No 102647

I HEREBY CERTIFY THAT

OASIS GREEN TANZANIA LIMITED

is this day incorporated under the Companies Act, 2002 and that the Company is Limited.

Given under my hand at Dar es salaam

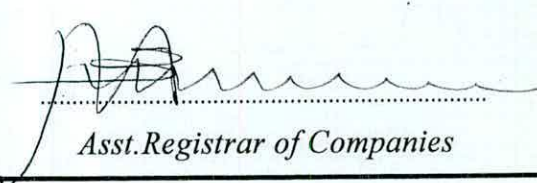
this 23RD day of SEPTEMBER**TWO THOUSAND AND THIRTEEN**
Asst. Registrar of Companies

SKETCH MAP SHOWING PROJECT LOCATION

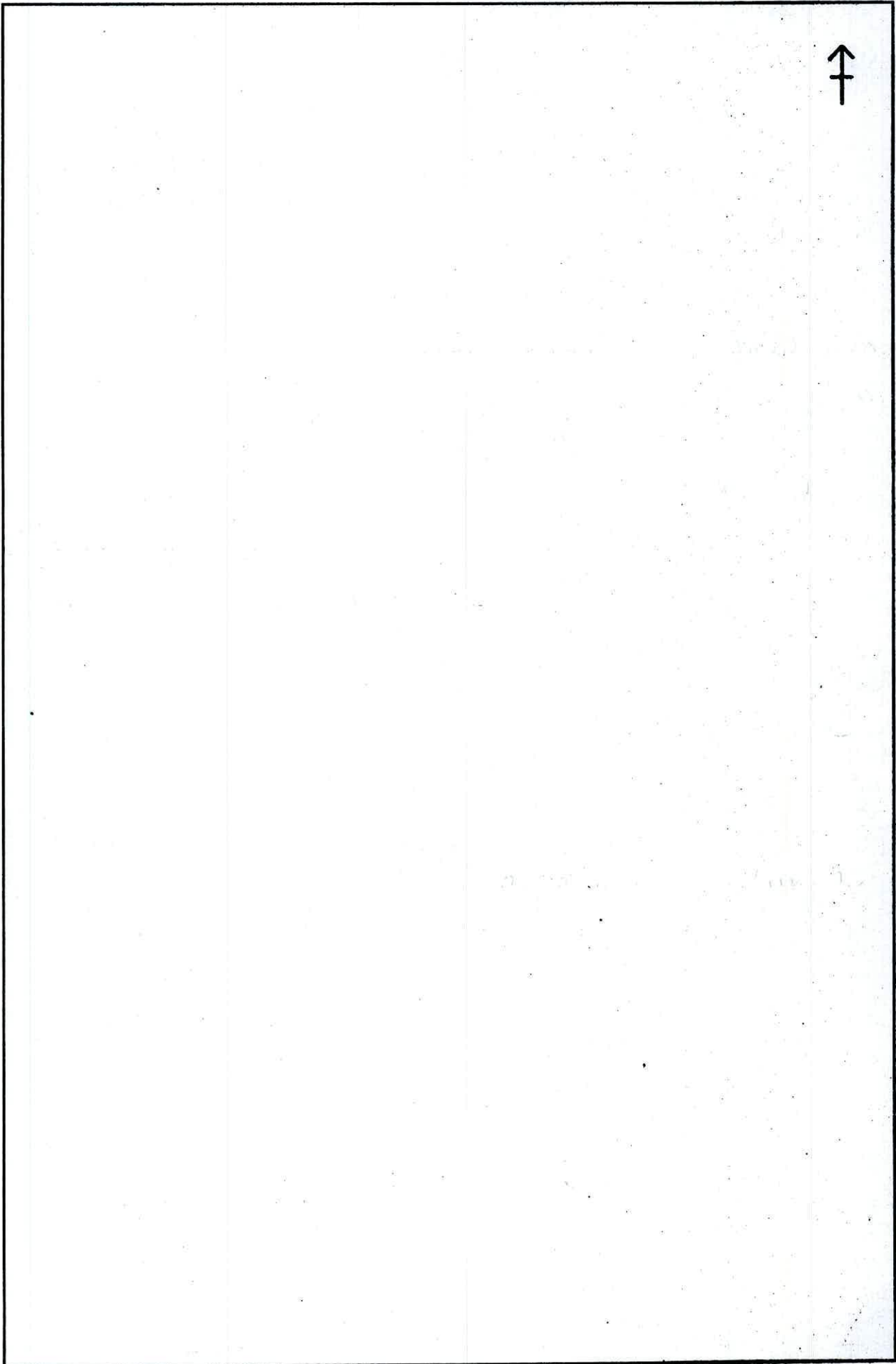





TANZANIA INVESTMENT CENTRE

REGISTRATION FORM

FOR

CERTIFICATE OF INCENTIVES

**(Tanzania Investment Act 1997, Section 17 and 18,
and the Investment Regulations:
Regulation 42, Government Notice No. 318A of 2002)**

Tanzania Investment Centre
9A & B Shaaban Robert Street
P. O. Box 938
DAR ES SALAAM
Tel. 022 2116328
Fax. 022 2118253
e-mail: information@tic.co.tz
Website: www.tic.co.tz

(Please fill the form in duplicate)

Investment Breakdown **US\$/Tshs.M**

Land/Building 60,000,000
Plant 3,215,064,000
Vehicles 155,500,000
Furniture & Fittings 23,000,000
Pre-expenses 20,000,000
Others
Working Capital 624,509,021
TOTAL 4,098,073,021

Contact Details:

Name: ISYU ADAM

Title: OPERATION MANAGER

Telephone: 0717 156474

Fax: —

Email: ISYUKYUGHA@GMAIL.COM

Payments to be made payable to:

TANZANIA INVESTMENT CENTRE
STANDARD CHARTERED BANK TANZANIA LTD.
SWIFT ADDRESS: **SCBLTZTX**
ACCOUNT NO.: **8702006002000**

APPLICATION SUMMARY

Company Name: OASIS GREEN (T) LTD

Certificate of Incorporation Number: 102647 Status:

Certificate of Incorporation Date: 23/09/2013

Post Box: 65365

Town: DAR ES SALAAM

Sector: FUEL & LUBRICANT SECTOR Sub-Sector: OIL

Investment Financing Plan in Million US\$/Tshs.

Foreign Equity	Local Equity	Foreign Loan	Local Loan
4 BILLION (TZS)	—	—	—

Project Objectives: Refining Waste oil in order to
restrain out impurities in order to produce
lubricant oil and grease.

Capacity: >40 litres per day

Employment: Foreign: 18 Local: >100 Total: >120

Implementation Period: 1 year

Project Location

Site/Plot/Block No.: Plot 10/10 Sukita - Bonde la Mpungu / Msimbazi 1

Street: Msimbazi - Sukita District: Ilala Region: Dar es Salaam
(Attach sketch map showing project location)

Shareholders	Nationality	%
MAHAMUD A. ALI	TANZANIAN	25
FAYROUZ KHAN	PAKISTAN	20
ABDUL A.D. FAHAD	SAUDI ARABIA	20
MARWAN ABOURAS	SYRIA	20
FAYAZ KHAN	PAKISTAN	15

7. The intended capital investment of the Company in terms of Section 2(2) of the Act is Tshs./US\$ TZS. 4 BILLION
8. The month and day of the financial year end is 30th JUNE, 2014

Note: **failure to provide all the required information will result in the return of the application by the Centre.**

I/We enclose a cheque/cash made payable to the Tanzania Investment Centre for Tshs./US\$ US\$ 100 Being the Registration Fees. **In the event this application is unsuccessful we understand that this fee will not be refunded.**

I, ISYU ADAM of Post Office Number 65365
DAR ES SALAAM do solemnly and sincerely declare that I am a director/duly authorized agent of OASIS GREEN(T) LTD

AND that all the requirements of the Tanzania Investment Act, 1997 in respect of matters precedent to the registration of the business enterprise under the Act and incidental thereto have been complied with, AND I make this solemn declaration conscientiously believing the same to be true.

Declared at Dar es Salaam *[Signature]*

The 24 day of OCTOBER 2013 }

Applicant

Before me:



.....
Commissioner for Oaths

UNITED REPUBLIC OF TANZANIA

THE TANZANIA INVESTMENT ACT

(No. 26 of 1997)

APPLICATION FOR REGISTRATION

(Made under Regulation 42)

To: The Executive Director
Tanzania Investment Centre
P. O. Box 938
DAR ES SALAAM
Tanzania

1. I/We ISYU ADAM
(director/directors/agent of OASIS GREEN TANZANIA LTD.
(name of business enterprise) apply for registration of CERTIFICATE OF INCENTIVES
under Section 17 of the Act and Part IV of the Investment Regulations, 2002.
2. The registered office of the company will be situated at SUKITA AREA, BONDE
LA MPUNGA, TABATA, ILALA, DAR ES SALAAM (PLOT 10/10)

Copies of the following documents are attached to this application:

- (i) The Memorandum and Articles of Association/or partnership agreement
- (ii) Certificate of Incorporation/Registration
- (iii) A copy of the Project Profile or Feasibility Study showing the implementation period, programme of implementation and operative date
- (iv) Evidence of financing and evidence of land ownership for the project
3. The Head Office of the Company will be situated at SUKITA, TABATA - PLOT 10/10
4. The Principal Officers of the Company are (1) ABDUL UWEZE
(2) VIAN KALAMAGE (3) HASSAN MAHAMUD
(4) ISYU ADAM
5. Auditors of the Company are DEMUS ASSOCIATES
6. The authorized share capital of the Company is Tshs./US\$ TZS 800,000,000/=
divided a 10,000 ordinary shares with nominal
value of TZS 80,000/=

**OASIS GREEN TANZANIA LIMITED
(PROCESSORS AND REFINERS
OF WASTE OIL - FACTORY)**

**CERTIFICATE OF
INCENTIVES PROPOSAL**

**SUBMITTED TO TANZANIA INVESTMENT
CENTRE AS PART REQUIREMENT FOR
APPLICATION FOR CERTIFICATE OF INCENTIVES**

OASIS GREEN TANZANIA LIMITED
(PROCESSORS AND REFINERS OF WASTE OIL - FACTORY)

FEASIBILITY STUDY

1.0 INTRODUCTION

Oasis Green Tanzania Limited has an ongoing project which deals with refining waste oil; the project is in initial stages for acquiring Processors and refiners of waste oil in order to start waste oil recycling activities. The management of the company has determined to retain its reputation by establishing the factory for high level of production level of lubricant oil and grease, it must be noted that waste oil recycling and refining involves machines called processors and refiners. These machines strain out the impurities such as water, insoluble matters, dirt, heavy metal, chemical compounds from oil drained from vehicles and other machines. The Company is seeking certificate of incentives from Tanzania Investment Centre for purchasing machineries for the Factory that involve processors and refiners machines. The factory's good services will be provided to customers by more than 100 employees at Factory that involve processors and refiners machines that will be located at Sukita Area Bonde la Mpunga, Tabata. The market for lubricant oil and grease for lessen friction between moving surfaces (lube oil) is very large for both in Tanzania, and foreign countries such as Malawi, Congo DRC, Rwanda, and Burundi. The main objective of the management is to become the major lubricant oil and grease for lessen friction between moving surfaces (lube oil), thus to improve and meet demands from existing and new market. At present, the best unique selling point in terms of business is that the company the capital to invest in a business. The management has taken a strategic decision of increasing its revenue by establishing and developing the factory for refining waste oil as its unique profit centre, the management expectation is that the value of the

company's turnover will increase substantially and hence increase the market share. From this study and analysis undertaken by the promoters and Consultant, the project is technically, feasible, financially and economically viable and environmentally friendly. This analysis will underpin company's business aspects toward its strategies and achieving progressive business success.

2.0 COMPANY PROFILE

2.1 Incorporation and Trading History

Oasis Green Tanzania Limited is registered under Companies act 2002 as limited company with certificate of incorporation number 102647 of 23rd September, 2013. Oasis Green Tanzania Limited is legally licensed to do the businesses with the head office at Dar es Salaam:

2.2 Shareholding Structure:

Authorized share capital according to memorandum of association is TZS. 800,000,000/=, divided as 10,000 ordinary shares with nominal value of TZS. 80,000/=, each. Issued and paid up share capital is TZS 800,000,000/= divided as 10,000 ordinary shares with nominal value of TZS 80,000/= each. Shareholders who are also directors of the Company

Name and Address of Shareholders	Shareholding
Mahamud Ahmed Alli, P. O. Box 65265, DAR ES SALAAM	2500 Shares
Fayrouz Khan P. O. Box 65265, DAR ES SALAAM	2000 Shares
Dr Abdul Aziz Dakheel Fahad, P. O. Box 65265, DAR ES SALAAM	2000 Shares

Unclaimed refund beyond three years will be forfeited



TANZANIA INVESTMENT CENTRE

Shaaban Robert Street, P.O. Box 938, Dar Es Salaam, Tel. +255 22 2116328-31, Fax: +255 22 2118253

RECEIPT REC013266

No.007224

Received from : OASIS GREEN (T) LTD

Address P.O. Box 65365DSM

Received the sum of (In words): ONE HUNDRED AND ZERO CENTS ONLY

Being payment in respect of : REGISTRATION FEES

Amount USD 100.00

Cash / Cheque No: D/deposit 24/10
Date : 24-Oct-2013

BUisso [Signature]
Receiving Officer

Executive Director
Tanzania Investment Centre

Marwan Abouras P. O. Box 65265, DAR ES SALAAM	2000 Shares
Fayaz Khan P. O. Box 65265, DAR ES SALAAM	1500 Shares

The management team:

The company has determined to reach its objectives for strengthening its operational demands; therefore, this proposal will be implemented at its head office in Dar es Salaam. The company has the following management framework for managing the ongoing and upcoming activities.

**OASIS GREEN TANZANIA LIMITED
ORGANIZATION CHART**

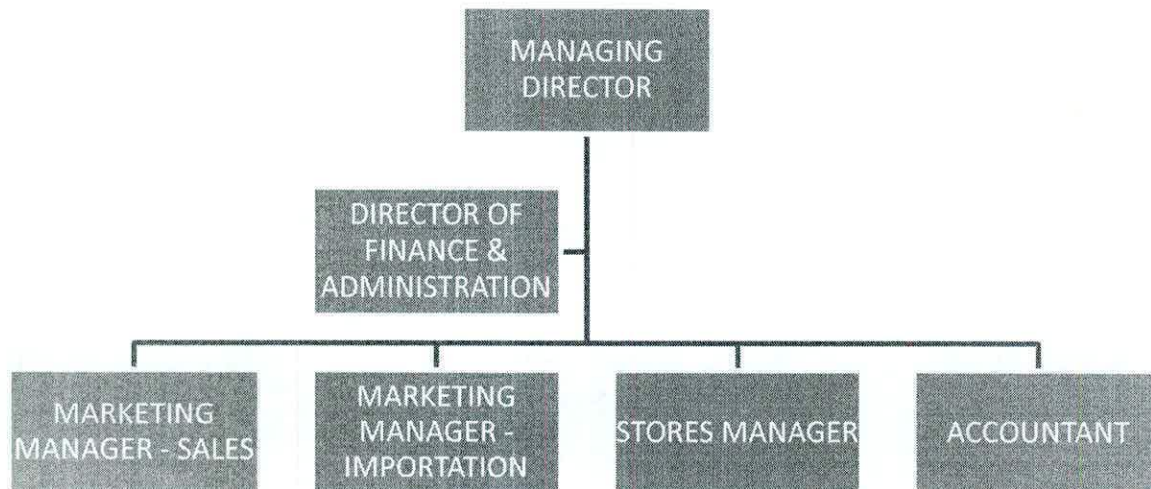

In addition to the management of Oasis Green Tanzania Limited, the company has employed other staff for Processors and refiners of waste oil, which will have a total of 100 employees who will be working at the factory.

2.3 Banker and Contacts Address/telephone numbers:

- **Banker:**

The Company is banking with FBME Bank Ltd at Samora Avenue Branch

- **Contact Address & Physical Location:**

The Company head office is located at Sukita Area Bonde la Mpunga, tabata, Ilala District, Dar es Salaam. The Office is located at this very industrial area within the City, Dar es Salaam city and also the office has combined with the company's showroom (outlet) which has 20 square meters. The company can be contacted through the following address.

Managing Director,

Oasis Green Tanzania Limited,

P. O. Box 65365, DAR ES SALAAM.

Physical Address: Sukita Area Bonde la Mpunga, tabata, Ilala District, Dar es Salaam.

3.0 STRATEGIC OBJECTIVES

In order to trigger new market as a means of establishing company's operations to its highest capacity, thus, the main objective for the company is to strengthen its working tools by acquiring machineries for production. It is clear that Fuel and related products - sector has lot of opportunities within the country, this creates an opportunity for goods and services provided by the company, and therefore we would like to meet demands from expected good clients through strengthening working tools. Hence, through this strategy, the company will be in the position to achieve progressive business success. The Company objective is to increase volume of sales of its products. Lubricant oil and grease for lessen friction between moving surfaces (lube oil) business in the local market has strong competition; however, the Company believes that it has an opportunity to market its products in Kenya, Rwanda, Malawi and other foreign countries and hence will increase chances for the Company to achieve its objective. Therefore part of marketing

strategy is to increase haulage capacity with aim of reaching the markets at lower cost.

Specific objectives are

- i. To acquire machineries for refining waste oil in order to lower the production cost for lubricant oil and grease for lessen friction between moving surfaces (lube oil)
- ii. To increase employment to young Tanzanians who went through VETA related studies
- iii. To ensure lubricant oil and grease for lessen friction between moving surfaces (lube oil) are produced and manufactured in Tanzania thus Refining waste oil - factory will be an example for local Tanzania lubricant oil and grease Company.
- iv. To continue training its staff particularly in the processing section to improve their skills, safety, and proper use and maintenance of machinery and tools.
- v. To be customer focused at the best and sound price

Currently, the company's business trend is very promising, and this is due to above core set of objectives.

Factory that involve processors and refiners machines – products

The factory is aiming into production of lubricant oil and grease for lessen friction between moving surfaces (lube oil). Productions for these products are in a very low level compared to lubricant oil and grease for lessen friction between moving surfaces (lube oil).

4.0 INVESTMENT COSTS AND FINANCING PLAN

4.1 Investment Costs

SN ITEM	Proposed Capital	PROPOSED ADDITIONAL	TOTAL
	TZS	TZS (US\$ 1 @ 1600)	TZS
1 Land and Buildings	60,000,000	-	60,000,000
2 Plant and Equipment	3,215,064,000	-	3,215,064,000
3 Motor Vehicles	155,500,000	-	155,500,000
4 Furniture, Fitt & Fixture	23,000,000	-	23,000,000
Total Fixed Assets	3,453,564,000	-	3,453,564,000
5 Working Capital	624,509,021	-	624,509,021
TOTAL INVESTMENT COSTS	4,078,073,021	-	4,078,073,021

4.2 Financing Plan

SN ITEM	EXISTING		
	EQUITY	LOAN	TOTAL
Source of Finance			
1 Land and Buildings	60,000,000	-	60,000,000
2 Plant and Equipment	3,215,064,000	-	3,215,064,000
3 Motor Vehicles	155,500,000	-	155,500,000
4 Furniture, Fitt & Fixture	23,000,000	-	23,000,000
5 Working Capital	624,509,021	-	624,509,021
	4,078,073,021	-	4,078,073,021

5.0 INDUSTRY SITUATION

5.1 Supply and Demand for Lubricant oil and grease

The growing market of lubricant oil and grease has shown an increasing demand due to the economic growth within the country. The demand and supply of lubricant oil and grease in Tanzania has come up due to an increasing construction of different industry revolution (such as steel and textile industries). In recent years imported lubricant oil and grease from other countries such as China has increased substantially as compared to export of lubricant oil and grease from Tanzania, this is a good indicator that the interior market for lubricant oil and grease can accommodate foreign investors as well. Hence this is a great opportunity for local investors in the sector to make more production in order to satisfy the existing market as well as to export to other foreign countries, the management of the company has determine to reach the above targeted economical objective for our country as whole. Therefore, the company has started by establishing Refining waste oil - factory in which the country can benefit as the production will be in the capacity to satisfy the existing market. Due to the fact that the management has already invested a total of TZS 10 million in academic research for waste oil recycling in Tanzania. One of observation made is that Tanzania companies are importing lubricant oil and grease from China, while Chinese business men are exporting natural resources from our country which is used to manufacture different products including lubricant oil and grease, hence we may recall this tactic done by foreigners as resold of our resources in different finished shape and in high prices. We believe that foreigners they used Tanzanian resources and they doubled or tripled their profit against the production cost.

5.2 The Market and the Edge:

The Factory that involve processors and refiners machines itself has a very promising potential in Tanzania, in the sense that most of Tanzanians are importing lubricant oil and grease for lessen friction between moving surfaces (lube oil) from other countries such as China; this creates more business opportunities for the company especially for Factory that involve processors and refiners machines in which it will manufacture lubricant oil and grease for lessen friction between moving surfaces (lube oil) to meet demand for the existing and new market. With an increase in economic growth, the management expects a steady increase in the market of around 50 to 65 per cent. Thus the project will bear positive results toward increase in the market share. Furthermore, Due to the fact that the management has been in the business for many years and this can significantly influence the current situation of the factory toward its goal. Also the management has increased its business network between to potential stakeholders in the sector, making it possible for the company to enhance competitive lubricant oil and grease prices and thus acquire more market share.

5.3 Lubricant oil and grease manufacture

In aspect of comparison between Chinese lubricant oil and grease compared to Refining waste oil – factories in Tanzania, the Chinese lubricant oil and grease are in very low quality with some nice packaging. This is due to the fact that Chinese lubricant oil and grease are produce by reducing the cost for its production in order to meet production cost against profit including costs for natural resources wastes which are usually imported from other countries, but the appearance of Chinese lubricant oil and grease is very attractive. According research evidences made by the management of the company in collaboration to company's consultant. The market for Chinese

local companies to export is between 21 to 30 percent, and the export is made to most Asian countries and America. While the market for Tanzanians local companies to export is non if not zero. Therefore, Tanzania entrepreneurs can perform better in the international market due to the chief characteristic of quality lubricant oil and grease produced. Production for hardwood lubricant oil and grease, flash lubricant oil and grease and flash lubricant oil and grease panel is as follows;

5.4 Uniqueness

Due to the fact that in Tanzania, there are few companies which is directly produced lubricant oil and grease and sale in high capacity as finished product (not by ordering). In comparison of Tanzania local Oil entrepreneurs to that of Refining waste oil - factories, we have identified number of unique selling points to our company. We have stipulated this uniqueness as follows

local Carpeting entrepreneurs	Refining waste oil - factorys (Oasis Green Tanzania Limited)
<ul style="list-style-type: none"> i. Not specialized in one product ii. Inconsistence in waste oil recycling and completions iii. Not trustworthy from customers due to delays iv. Not promise taking v. Low standard and quality due to the low quality production equipments vi. Low delivery due to low production level and low stocks 	<ul style="list-style-type: none"> i. Specialized in Modern Waste oil recycling ii. Consistency in production level of lubricant oil and grease per day iii. Lubricant oil and grease will be ready in showrooms for selling iv. Promise taking v. Standard and quality of lubricant oil and grease are in high level due to modern production equipments vi. Delivery will be very high due to production level and high stock

5.6 Competition

The business for lubricant oil and grease has attracted many local and foreign companies; most of companies deal with selling of ready-made lubricant oil and grease. This is due to low or few entry barriers in the business, but also the availability of such type of lubricant oil and grease from China. However, due to good policy from Tanzania government in creating different opportunities for local Tanzania companies to compete in the market. Factory that involve processors and refiners machines (a sister factory to Oasis Green Tanzania Limited) has started production different types of lubricant oil and grease. This measure brings competition relief to established local companies such as Oasis Green Tanzania Limited. It is very obvious, there are no single local Tanzanian company involve in refining waste oil to the required production level and by using the modern equipment. Hence, there is no direct local competitor that manufactures hardwood lubricant oil and grease and flash lubricant oil and grease. In nutshell, the major competitors of the company are those who import finished lubricant oil and grease from China and Kenya.

Oasis Green Tanzania Limited aims to become a leading company in lubricant oil and grease from refining waste oil. The company is targeting clients from local area and government authorities within the country as a priority segments. By supplying its products at well budgeted prices that will allow the company to attract many customers, hence the company will establish itself as a Leading company in building sector and other related company's products. This strategy is possible due to the fact that the market is large and it is needed in the country.

5.7 Competitive Advantage

The chief characteristic of Oasis Green Tanzania Limited is its brand name which is very competitive in the industry. The company is flexible to different types of clients from local companies and government authorities within the country as a priority segments. The Company strategy is to strengthen its working tools by acquiring modern equipments and reaching the markets at minimum production costs.

5.8 Project Phases and Timing

The company is expecting to acquire equipments from Abroad; these proposed equipments will be installed at the company's factory at Sukita Area Bonde la Mpunga, Tabata. Emphasizing on the project, the Strategic Programme is to develop the Refining waste oil - factory, The useful tool that will assist to oversee the project for Refining waste oil - factory is by using the Critical Path Method.

Key activities of the Refining waste oil - factorys are as follows

Task No	Activity Completed	Task	Preceding Activity	Duration (Months)
A	X	Conduct lubricant oil and grease research in China and Tanzania	-	4
B	X	Acquire Site	A	2
C	X	Legal registration	B	3
D		Procurement for assets to be installed	A,B,C	1
E		Employing technicians and other casual workers for early start of activities	D,C	3
F		Develop business plan for seeking additional financial assistance	E	1
G		Acquiring additional equipments	F	1
H		Installing equipments for Progression of	G,F	2

Critical Path Diagram

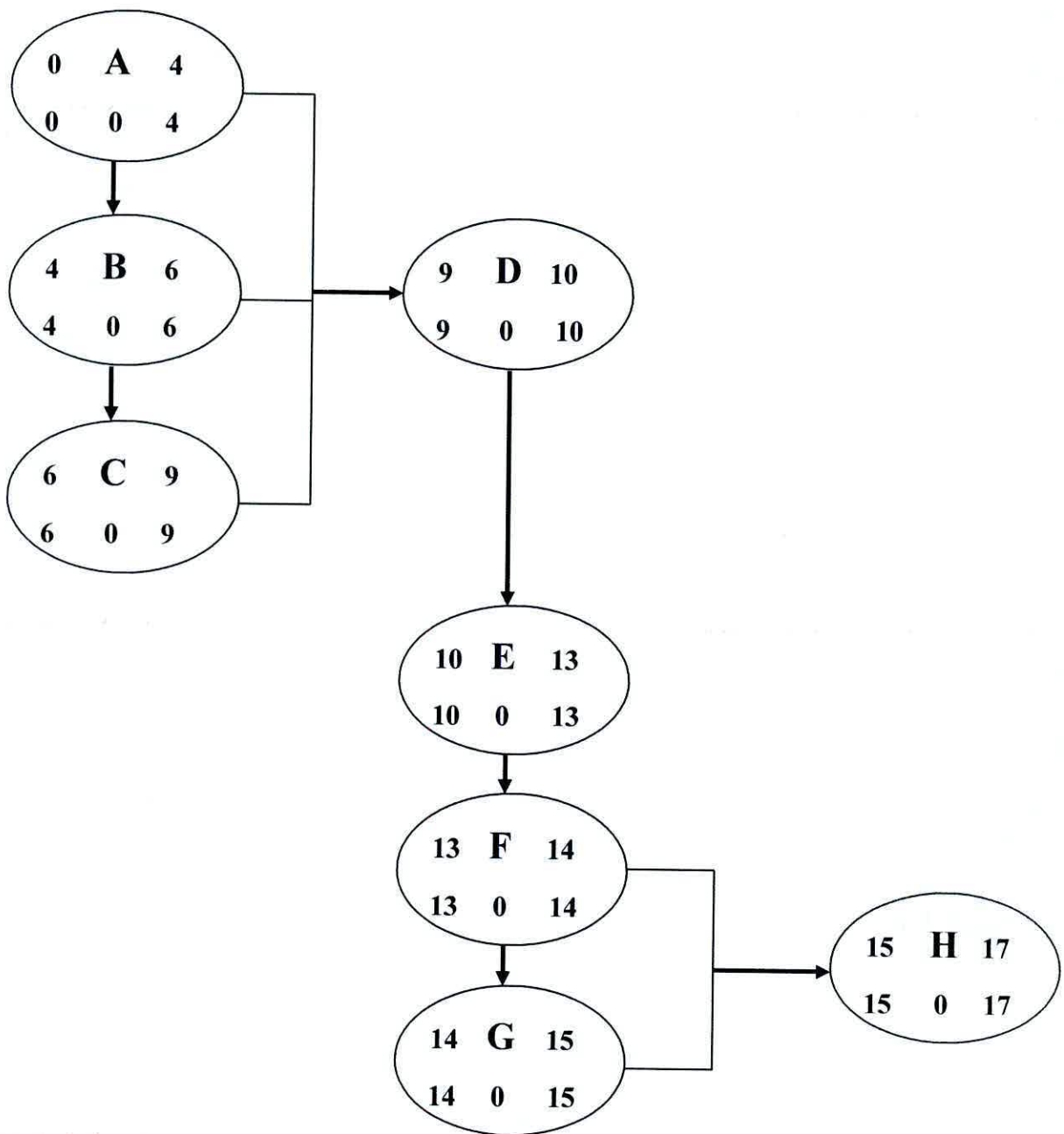

Critical Activities are A,B,C,D,E,F & G. Therefore the expected time for completion of the project for high capacity commencement is 17 months. However, stage A (Conduct lubricant oil and grease research in China and Tanzania) to stage E (Employing technicians and other casual workers for early start of activities) have already implemented by the management. To the time of submission of this business plan, the remaining stages are G and H

Task No.	Preceding Activity	Duration (Months)	EST	EFT	LFT	1	2	3	4	5	6	7	8	9	10	11	12	13	14	15	16	17
× A	-	4	0	4	4	█	█	█	█													
× B	A	2	4	6	6				█	█												
× C	B	3	6	9	9					█	█	█										
× D	A,B,C	1	9	10	10									█								
× E	D,C	3	10	13	13										█	█	█					
× F	E	1	13	14	14														█			
G	F	1	14	15	15															█		
H	GF	2	15	17	17																█	█

Note; all activities with symbol '×' means activity "completed"

The management of the company anticipates that the project can commence as soon as possible due to the fact that other stages have already been implemented by the management. Therefore, the remaining stages include that of acquiring the proposed equipments and progression of the project. By referring to critical path method of Refining waste oil - factorys, the remaining stages are critical stages which are acquisition and acquiring required equipments to carry on with the project.

6.0 TECHNICAL FEASIBILITY AND ENVIRONMENT

6.1 Brief description of the project

The proposed project is to install equipments in order for the factory to make production to its high capacity. In addition to that the company has

determined to be the first company in Tanzania that manufactures lubricant oil and grease to the maximum level as a local Tanzanian company, lube oil is used for lessen friction between moving surfaces. Therefore, The Company is seeking certificate of incentives in order to sustain the working tools that involve processors and refiners machines. The management of the company is seeking certificate of incentives from Tanzania Investment Centre.

Once machineries have delivered from supplier, the equipments and machineries will go through technical inspection to establish any defects. Any comprehensive service and repairs will be carried by the manufacturer company as customer's guarantee. Oasis Green Tanzania Limited determines to maintain its reputations from its stakeholders including financial institutions.

6.0 FINANCIAL PERFORMANCE AND FORECAST

6.1 Financial Forecast:

Revenue forecast is based on the following assumptions

- Revenue will depend on number of all types of lubricant oil and grease produced per day
- Refining waste oil - factory is expected to earn a sales of 2.8 billion a year
- No projections for re-investment of surplus cash generated by the business.
- We have applied zero inflation rates on revenue and expenses on the premise that any increase in operating expenses resulted.
- The company expect to generate an average of total of TZS 230 Million per month

- The Company expects to employ more than 100 people and we expect to employ double of the existing number of employees once the project is fully functioning.

7.0 PROJECT POTENTIALITY

(a) Estimated Development and Financial Benefits.

- Once exporting of company's production starts, we expect that the project will bring in the foreign funds by exporting its products to the targeted neighboring countries. We expect in that targeted objective, the company will endure in the business as a leading company.
- In additional; we expect that the Refining waste oil - factory project will generate direct employment for over 100 Tanzania residents and many others indirectly and thus helping the leaving standards in the country. By creating a number of employments, the company will be in position to contribute into the economic sustainability of the country as whole.
- Through paying taxes especially corporate tax, the company will increase the government revenue, but also the company will act as government agency to collect value added tax for its products.
- The increase in business network is very important for large business like that of Oasis (Refining waste oil - factory), that is to say the business will add value to networking stakeholders in hardware business.

(b) Conclusion:

We conclude that based in above critical analysis for Refining waste oil - factory-project, it shows a very promising endurance and financial performance due to the company's establishment plan. The progression of project will bear a positive result due to the fact that the management has reputable reputation. The immediate and long-term benefits of the project are

quite attractive from everybody's angle. The analysis depicts that given good management and subject to timely approval of the certificate of Incentives. All together will emphasize a clever positioning of the business against competitors toward attain profitability and to be economically viable. In nutshell from this analysis and evaluation of the proposed factory is technically, commercially and financially feasible and viable. The timing of the project is also very correct and the same is desirable from nations' viewpoint. It is therefore recommended that the company is richly deserves the certificate of incentives from Tanzania Investment Centre.

CASH FLOW PROJECTIONS FOR THE NEXT 12 MONTHS OF 2013/2014 (FIGURES IN TSHS. IN '000')

PARTICULARS	Nov-13	Dec-13	Jan-14	Feb-14	Mar-14	Apr-14	May-14	Jun-14	Jul-14	Aug-14	Sep-14	Oct-14	TOTAL
Cash Inflows:													
Sales Income	233,027	234,193	235,364	236,540	237,723	238,912	240,106	241,307	242,513	243,726	244,945	246,169	2,874,525
TOTAL CASH INFLOW	233,027	234,193	235,364	236,540	237,723	238,912	240,106	241,307	242,513	243,726	244,945	246,169	2,874,525
CASH OUTFLOWS:													
Purchases of waste oil	143,610	81,858	79,402	77,020	74,709	89,576	116,360	130,905	117,814	106,033	95,430	85,887	1,198,603
Salaries and Wages	15,380	15,380	15,380	15,380	15,380	15,380	15,380	15,380	15,380	15,380	15,380	15,380	184,560
Rent	1,167	1,167	1,167	1,167	1,167	1,167	1,167	1,167	1,167	1,167	1,167	1,167	14,000
Packing material	747	750	752	754	756	759	761	763	765	768	770	772	9,118
Printing and Stationery	405	420	420	420	420	420	420	420	420	420	420	420	5,025
Motor Vehicle Repairs & Maintenance	4,133	4,174	4,216	4,258	4,301	4,344	4,387	4,431	4,475	4,520	4,565	4,611	52,415
Motor Vehicle Running Exp	750	757	765	773	780	788	796	804	812	820	828	837	9,510
Business Traveling	3,381	3,415	3,449	3,483	3,518	3,553	3,589	3,625	3,661	3,698	3,735	3,772	42,879
NSSF Contribution	330	333	336	340	343	347	350	353	357	361	364	368	4,181
Sk Development Levy	198	200	202	204	206	208	210	212	214	216	219	221	2,509
Business Licence & Registrar	150	150	150	150	150	150	150	150	150	150	150	150	1,800
Local Transport	2,307	2,330	2,354	2,377	2,401	2,425	2,449	2,474	2,498	2,523	2,549	2,574	29,260
Shop Cleaning Expenses	212	212	212	212	212	212	212	212	212	212	212	212	2,543
Telephone and Postage	746	754	761	769	776	784	792	800	808	816	824	832	9,463
Water and Electricity	290	293	296	299	302	305	308	311	315	318	321	324	3,684
Security Charges	2,163	2,184	2,206	2,228	2,251	2,273	2,296	2,319	2,342	2,365	2,389	2,413	27,430
Facilitation fee	2,600	-	-	-	-	-	-	-	-	-	-	-	2,600
Bank Charges	41	41	42	42	43	43	44	44	44	45	45	46	520
Audit Fees	2,500	-	-	-	-	-	-	-	-	-	-	-	2,500
Office General Expenses	1,393	1,407	1,421	1,435	1,450	1,464	1,479	1,493	1,508	1,523	1,539	1,554	17,666
Directors Remuneration	1,550	1,566	1,581	1,597	1,613	1,629	1,645	1,662	1,678	1,695	1,712	1,729	19,658
TOTAL CASH OUTFLOWS	184,053	117,390	115,112	112,908	110,778	125,827	152,794	167,525	154,622	143,030	132,618	123,268	1,639,925
NET CASH FLOWS	48,975	116,802	120,252	123,632	126,945	113,085	87,312	73,782	87,891	100,696	112,326	122,901	1,234,600
OPENING BALANCE	-	48,975	165,777	286,029	409,661	536,607	649,691	737,003	810,785	898,676	999,372	1,111,699	-
CUMULATIVE NET CASH FLOWS	48,975	165,777	286,029	409,661	536,607	649,691	737,003	810,785	898,676	999,372	1,111,699	1,234,600	1,234,600

CASH FLOW PROJECTIONS FOR THE NEXT 12 MONTHS OF 2014/2015 (FIGURES IN TSHS. IN '000')

PARTICULARS	Nov-14	Dec-14	Jan-15	Feb-15	Mar-15	Apr-15	May-15	Jun-15	Jul-15	Aug-15	Sep-15	Oct-15	TOTAL
Cash Inflows:													
Sales Income	246,169	247,400	248,637	249,880	251,130	252,385	253,647	254,915	256,190	257,471	258,758	260,052	3,036,636
TOTAL CASH INFLOW	246,169	247,400	248,637	249,880	251,130	252,385	253,647	254,915	256,190	257,471	258,758	260,052	3,036,636
CASH OUTFLOWS:													
Purchases of waste oil	152,030	86,657	84,057	81,536	79,090	94,828	123,182	138,580	124,722	112,250	101,025	90,922	1,268,879
Salaries and Wages	16,450	16,450	16,450	16,450	16,450	16,450	16,450	16,450	16,450	16,450	16,450	16,450	197,400
Rent	1,240	1,240	1,240	1,240	1,240	1,240	1,240	1,240	1,240	1,240	1,240	1,240	14,880
Packing material	772	775	777	779	782	784	786	789	791	794	796	798	9,423
Printing and Stationery	420	420	420	420	420	420	420	420	420	420	420	420	5,040
Motor Vehicle Repairs & Maintenance	4,611	4,657	4,704	4,751	4,798	4,846	4,895	4,944	4,993	5,043	5,093	5,144	58,478
Motor Vehicle Running Exp	837	845	853	862	871	879	888	897	906	915	924	933	10,610
Business Traveling	3,772	3,810	3,848	3,886	3,925	3,964	4,004	4,044	4,085	4,125	4,167	4,208	47,839
NSSF Contribution	368	371	375	379	383	387	390	394	398	402	406	410	4,665
Skills Development Levy	221	223	225	227	230	232	234	237	239	241	244	246	2,799
Business Licence & Registra	150	150	150	150	150	150	150	150	150	150	150	150	1,800
Local Transport	2,574	2,600	2,626	2,652	2,679	2,705	2,732	2,760	2,787	2,815	2,843	2,872	32,645
Shop Cleaning Expenses	212	212	212	212	212	212	212	212	212	212	212	212	2,543
Telephone and Postage	832	841	849	858	866	875	884	892	901	910	920	929	10,557
Water and Electricity	324	327	331	334	337	341	344	347	351	354	358	362	4,110
Security Charges	2,413	2,437	2,462	2,486	2,511	2,536	2,561	2,587	2,613	2,639	2,665	2,692	30,603
Facilitation fee	2,600	-	-	-	-	-	-	-	-	-	-	-	2,600
Bank Charges	46	46	47	47	48	48	49	49	50	50	51	51	581
Audit Fees	3,000	-	-	-	-	-	-	-	-	-	-	-	3,000
Office General Expenses	1,554	1,570	1,585	1,601	1,617	1,633	1,650	1,666	1,683	1,700	1,717	1,734	19,710
Directors Remuneration	1,729	1,747	1,764	1,782	1,800	1,817	1,836	1,854	1,873	1,891	1,910	1,929	21,932
TOTAL CASH OUTFLOWS	196,155	125,377	122,975	120,652	118,407	134,349	162,907	178,512	164,863	152,602	141,590	131,703	1,750,093
NET CASH FLOWS	50,014	122,023	125,663	129,228	132,723	118,037	90,740	76,403	91,327	104,869	117,168	128,349	1,286,543
OPENING BALANCE	-	50,014	172,037	297,700	426,928	559,651	677,688	768,428	844,831	936,158	1,041,027	1,158,195	-
CUMULATIVE NET CASH FLOWS	50,014	172,037	297,700	426,928	559,651	677,688	768,428	844,831	936,158	1,041,027	1,158,195	1,286,543	1,286,543

CASH FLOW PROJECTIONS FOR THE NEXT 12 MONTHS OF 2015/2016 (FIGURES IN TSHS. IN '000')

PARTICULARS	Nov-15	Dec-15	Jan-16	Feb-16	Mar-16	Apr-16	May-16	Jun-16	Jul-16	Aug-16	Sep-16	Oct-16	TOTAL
Cash Inflows:													
Sales Income	260,052	261,352	262,659	263,972	265,292	266,619	267,952	269,292	270,638	271,991	273,351	274,718	3,207,890
TOTAL CASH INFLOW	260,052	261,352	262,659	263,972	265,292	266,619	267,952	269,292	270,638	271,991	273,351	274,718	3,207,890
CASH OUTFLOWS:													
Purchases of waste oil	165,420	94,289	91,461	88,717	86,055	103,180	134,031	150,785	135,707	122,136	109,922	98,930	1,380,635
Salaries and Wages	16,550	16,550	16,550	16,550	16,550	16,550	16,550	16,550	16,550	16,550	16,550	16,550	198,600
Rent	1,350	1,350	1,350	1,350	1,350	1,350	1,350	1,350	1,350	1,350	1,350	1,350	16,200
Packing material	798	801	803	805	808	810	813	815	818	820	823	825	9,739
Printing and Stationery	420	420	420	420	420	420	420	420	420	420	420	420	5,040
Motor Vehicle Repairs & Maintenance	5,144	5,196	5,248	5,300	5,353	5,407	5,461	5,515	5,570	5,626	5,682	5,739	65,242
Motor Vehicle Running Exp	933	943	952	962	971	981	991	1,001	1,011	1,021	1,031	1,041	11,837
Business Traveling	4,208	4,250	4,293	4,336	4,379	4,423	4,467	4,512	4,557	4,603	4,649	4,695	53,373
SSF Contribution	410	414	419	423	427	431	436	440	444	449	453	458	5,204
Skills Development Levy	246	249	251	254	256	259	261	264	267	269	272	275	3,123
Business Licence & Registra	150	150	150	150	150	150	150	150	150	150	150	150	1,800
Local Transport	2,872	2,900	2,929	2,959	2,988	3,018	3,048	3,079	3,110	3,141	3,172	3,204	36,421
Shop Cleaning Expenses	212	212	212	212	212	212	212	212	212	212	212	212	2,543
Telephone and Postage	929	938	947	957	966	976	986	996	1,006	1,016	1,026	1,036	11,779
Water and Electricity	362	365	369	373	376	380	384	388	392	395	399	403	4,586
Security Charges	2,692	2,719	2,746	2,774	2,801	2,829	2,858	2,886	2,915	2,944	2,974	3,003	34,143
Facilitation fee	2,800	-	-	-	-	-	-	-	-	-	-	-	2,800
Bank Charges	51	52	52	53	53	54	54	55	55	56	56	57	648
Audit Fees	3,500	-	-	-	-	-	-	-	-	-	-	-	3,500
Office General Expenses	1,734	1,751	1,769	1,786	1,804	1,822	1,840	1,859	1,877	1,896	1,915	1,934	21,989
Directors Remuneration	1,929	1,949	1,968	1,988	2,008	2,028	2,048	2,068	2,089	2,110	2,131	2,152	24,468
TOTAL CASH OUTFLOWS	212,711	135,498	132,889	130,367	127,930	145,281	176,360	193,345	178,500	165,164	153,188	142,436	1,893,669
NET CASH FLOWS	47,341	125,854	129,770	133,606	137,363	121,338	91,592	75,947	92,139	106,827	120,163	132,282	1,314,221
OPENING BALANCE	-	47,341	173,196	302,966	436,571	573,934	695,272	786,864	862,811	954,949	1,061,776	1,181,939	-
CUMULATIVE NET CASH FLOWS	47,341	173,196	302,966	436,571	573,934	695,272	786,864	862,811	954,949	1,061,776	1,181,939	1,314,221	1,314,221

CASH FLOW PROJECTIONS FOR THE NEXT 12 MONTHS OF 2016/2017 (FIGURES IN TSHS. IN '000')

PARTICULARS	Nov-16	Dec-16	Jan-17	Feb-17	Mar-17	Apr-17	May-17	Jun-17	Jul-17	Aug-17	Sep-17	Oct-17	TOTAL
Cash Inflows:													
Sales Income	274,718	276,092	277,472	278,859	280,254	281,655	283,063	284,479	285,901	287,330	288,767	290,211	3,388,801
TOTAL CASH INFLOW	274,718	276,092	277,472	278,859	280,254	281,655	283,063	284,479	285,901	287,330	288,767	290,211	3,388,801
CASH OUTFLOWS:													
Purchases of waste oil	175,420	99,989	96,990	94,080	91,258	109,418	142,134	159,901	143,911	129,519	116,568	104,911	1,464,097
Salaries and Wages	16,700	16,700	16,700	16,700	16,700	16,700	16,700	16,700	16,700	16,700	16,700	16,700	200,400
Rent	1,450	1,450	1,450	1,450	1,450	1,450	1,450	1,450	1,450	1,450	1,450	1,450	17,400
Packing material	825	827	830	832	835	837	840	843	845	848	850	853	10,065
Printing and Stationery	420	420	420	420	420	420	420	420	420	420	420	420	5,040
Motor Vehicle Repairs & Maintenance	5,739	5,797	5,855	5,913	5,972	6,032	6,092	6,153	6,215	6,277	6,340	6,403	72,788
Motor Vehicle Running Exp	1,041	1,052	1,062	1,073	1,084	1,094	1,105	1,116	1,128	1,139	1,150	1,162	13,206
Business Traveling	4,695	4,742	4,790	4,837	4,886	4,935	4,984	5,034	5,084	5,135	5,186	5,238	59,546
NSSF Contribution	458	462	467	472	476	481	486	491	496	501	506	511	5,806
Skills Development Levy	275	277	280	283	286	289	292	295	297	300	303	306	3,484
Business Licence & Registration	150	150	150	150	150	150	150	150	150	150	150	150	1,800
Local Transport	3,204	3,236	3,268	3,301	3,334	3,367	3,401	3,435	3,469	3,504	3,539	3,574	40,633
Shop Cleaning Expenses	212	212	212	212	212	212	212	212	212	212	212	212	2,543
Telephone and Postage	1,036	1,047	1,057	1,068	1,078	1,089	1,100	1,111	1,122	1,133	1,145	1,156	13,141
Water and Electricity	403	407	412	416	420	424	428	432	437	441	446	450	5,116
Security Charges	3,003	3,034	3,064	3,095	3,125	3,157	3,188	3,220	3,252	3,285	3,318	3,351	38,092
Facilitation fee	2,900	-	-	-	-	-	-	-	-	-	-	-	2,900
Bank Charges	57	58	58	59	59	60	60	61	62	62	63	64	723
Audit Fees	3,600	-	-	-	-	-	-	-	-	-	-	-	3,600
Office General Expenses	1,934	1,954	1,973	1,993	2,013	2,033	2,053	2,074	2,095	2,116	2,137	2,158	24,533
Directors Remuneration	2,152	2,174	2,196	2,218	2,240	2,262	2,285	2,308	2,331	2,354	2,378	2,401	27,299
TOTAL CASH OUTFLOWS	225,676	143,988	141,233	138,571	135,998	154,410	187,381	205,405	189,675	175,546	162,859	151,470	2,012,213
NET CASH FLOWS	49,042	132,104	136,239	140,289	144,256	127,245	95,682	79,073	96,226	111,784	125,908	138,741	1,376,588
OPENING BALANCE	-	49,042	181,146	317,385	457,674	601,930	729,174	824,856	903,930	1,000,156	1,111,940	1,237,848	-
CUMULATIVE NET CASH FLOWS	49,042	181,146	317,385	457,674	601,930	729,174	824,856	903,930	1,000,156	1,111,940	1,237,848	1,376,588	1,376,588

CASH FLOW PROJECTIONS FOR THE NEXT 12 MONTHS OF 2017/2018 (FIGURES IN TSHS. IN '000')

PARTICULARS	Nov-17	Dec-17	Jan-18	Feb-18	Mar-18	Apr-18	May-18	Jun-18	Jul-18	Aug-18	Sep-18	Oct-18	TOTAL
Cash Inflows:													
Sales Income	290,211	291,662	293,120	294,586	296,059	297,539	299,027	300,522	302,025	303,535	305,052	306,578	3,579,916
TOTAL CASH INFLOW	290,211	291,662	293,120	294,586	296,059	297,539	299,027	300,522	302,025	303,535	305,052	306,578	3,579,916
CASH OUTFLOWS:													
Purchases of waste oil	181,420	103,409	100,307	97,298	94,379	113,160	146,995	165,370	148,833	133,949	120,555	108,499	1,514,175
Salaries and Wages	18,100	18,100	18,100	18,100	18,100	18,100	18,100	18,100	18,100	18,100	18,100	18,100	217,200
Rent	1,550	1,550	1,550	1,550	1,550	1,550	1,550	1,550	1,550	1,550	1,550	1,550	18,600
Packing material	853	855	858	860	863	866	868	871	873	876	879	881	10,402
Printing and Stationery	420	420	420	420	420	420	420	420	420	420	420	420	5,040
Motor Vehicle Repairs & Maintenance	6,403	6,467	6,532	6,597	6,663	6,730	6,797	6,865	6,934	7,003	7,073	7,144	81,208
Motor Vehicle Running Exp	1,162	1,173	1,185	1,197	1,209	1,221	1,233	1,246	1,258	1,271	1,283	1,296	14,734
Business Traveling	5,238	5,291	5,343	5,397	5,451	5,505	5,560	5,616	5,672	5,729	5,786	5,844	66,434
NSSF Contribution	511	516	521	526	532	537	542	548	553	559	564	570	6,478
Skills Development Levy	306	310	313	316	319	322	325	329	332	335	339	342	3,887
Business Licence & Registrar	150	150	150	150	150	150	150	150	150	150	150	150	1,800
Local Transport	3,574	3,610	3,646	3,683	3,720	3,757	3,794	3,832	3,871	3,909	3,948	3,988	45,333
Shop Cleaning Expenses	212	212	212	212	212	212	212	212	212	212	212	212	2,543
Telephone and Postage	1,156	1,168	1,179	1,191	1,203	1,215	1,227	1,239	1,252	1,264	1,277	1,290	14,661
Water and Electricity	450	455	459	464	468	473	478	483	487	492	497	502	5,708
Security Charges	3,351	3,384	3,418	3,452	3,487	3,522	3,557	3,593	3,629	3,665	3,701	3,739	42,498
Facilitation fee	3,000	-	-	-	-	-	-	-	-	-	-	-	3,000
Bank Charges	64	64	65	66	66	67	67	68	69	70	70	71	806
Audit Fees	3,700	-	-	-	-	-	-	-	-	-	-	-	3,700
Office General Expenses	2,158	2,180	2,202	2,224	2,246	2,268	2,291	2,314	2,337	2,360	2,384	2,408	27,371
Directors Remuneration	2,401	2,425	2,450	2,474	2,499	2,524	2,549	2,575	2,600	2,626	2,653	2,679	30,456
TOTAL CASH OUTFLOWS	236,180	151,739	148,910	146,176	143,536	162,599	196,718	215,379	199,131	184,541	171,441	159,684	2,116,033
NET CASH FLOWS	54,031	139,923	144,210	148,410	152,523	134,941	102,309	85,143	102,893	118,994	133,611	146,893	1,463,882
OPENING BALANCE	-	54,031	193,954	338,165	486,574	639,097	774,038	876,347	961,490	1,064,384	1,183,378	1,316,989	-
CUMULATIVE NET CASH FLOWS	54,031	193,954	338,165	486,574	639,097	774,038	876,347	961,490	1,064,384	1,183,378	1,316,989	1,463,882	1,463,882

INCOME STATEMENTS

	2013	2014	2015	2016	2017
	TZS'000	TZS'000	TZS'000	TZS'000	TZS'000
Sales Income	2,874,525	3,036,636	3,207,890	3,388,801	3,579,916
Less: Direct Costs	1,198,603	1,268,879	1,380,635	1,464,097	1,514,175
Gross Profit	1,675,921	1,767,757	1,827,255	1,924,704	2,065,741
Less: Operating Expenses					
Salaries and Wages	184,560	197,400	198,600	200,400	217,200
Rent	14,000	14,880	16,200	17,400	18,600
Packing material	9,118	9,423	9,739	10,065	10,402
Printing and Stationery	5,025	5,040	5,040	5,040	5,040
Motor Vehicle Repairs & Maintenance	52,415	58,478	65,242	72,788	81,208
Motor Vehicle Running Exp	9,510	10,610	11,837	13,206	14,734
Business Traveling	42,879	47,839	53,373	59,546	66,434
NSSF Contribution	4,181	4,665	5,204	5,806	6,478
Skills Development Levy	2,509	2,799	3,123	3,484	3,887
Business Licence & Registration	1,800	1,800	1,800	1,800	1,800
Local Transport	29,260	32,645	36,421	40,633	45,333
Shop Cleaning Expenses	2,543	2,543	2,543	2,543	2,543
Telephone and Postage	9,463	10,557	11,779	13,141	14,661
Water and Electricity	3,684	4,110	4,586	5,116	5,708
Security Charges	27,430	30,603	34,143	38,092	42,498
Facilitation fee	2,600	2,600	2,800	2,900	3,000
Bank Charges	520	581	648	723	806
Audit Fees	2,500	3,000	3,500	3,600	3,700
Office General Expenses	17,666	19,710	21,989	24,533	27,371
Directors Remuneration	19,658	21,932	24,468	27,299	30,456
Depreciation	421,896	371,459	325,026	284,398	248,848
Total Operating Expenses	863,217	852,673	838,060	832,514	850,707
Profit Before Tax	812,704	915,085	989,195	1,092,190	1,215,034
Less: Income Tax	243,811	274,525	296,758	327,657	364,510
Profit After Tax	568,893	640,559	692,436	764,533	850,524

BALANCE SHEETS

	2013	2014	2015	2016	2017
	TZS'000	TZS'000	TZS'000	TZS'000	TZS'000
FIXED ASSETS (Net)	3,031,669	2,660,210	2,335,184	2,050,786	1,801,938
CURRENT ASSETS					
Cash Balance	231,600	233,152	243,807	254,949	266,600
Stock	598,603	668,879	780,635	864,097	914,175
Creditors	-	972,322	1,891,506	2,879,276	3,957,182
Total Current Assets	830,203	1,874,353	2,915,948	3,998,322	5,137,957
CURRENT LIABILITIES					
Accrued Expenses	4,168	5,585	7,484	10,029	13,438
Tax due	243,811	274,525	296,758	327,657	364,510
Total Current Liabilities	247,979	280,111	304,243	337,686	377,949
Net Current Assets	582,224	1,594,242	2,611,705	3,660,636	4,760,008
TOTAL NET ASSETS	3,613,893	4,254,452	4,946,889	5,711,422	6,561,946
FINANCED BY					
Share Capital	800,000	800,000	800,000	800,000	800,000
Advanced Share Capital	3,045,000	3,045,000	3,045,000	3,045,000	3,045,000
Retained Earnings	568,893	1,209,452	1,901,889	2,666,422	3,516,946
Total Equity	3,613,893	4,254,452	4,946,889	5,711,422	6,561,946

FIXED ASSETS

DESCRIPTION/ASSET CATEGORY	LAND AND BUILDINGS	FURNITURE & FITTINGS	MACHINERY & EQUIPMENT	TOTAL
COST				
Balance as at 01/01/2014	60,000,000	23,000,000	3,370,564,000	3,453,564,000
Additions	-	-	-	-
Balance as at 31/12/2014	60,000,000	23,000,000	3,370,564,000	3,453,564,000
DEPRECIATION				
Balance as at 01/01/2014	-	-	-	-
Charge for the Year	-	575,000	421,320,500	421,895,500
Balance as at 31/12/2014	-	575,000	421,320,500	421,895,500
NET BOOK VALUE				
Balance as at 31/12/2014	60,000,000	22,425,000	2,949,243,500	3,031,668,500

DESCRIPTION/ASSET CATEGORY	LAND AND BUILDINGS	FURNITURE & FITTINGS	MACHINERY & EQUIPMENT	TOTAL
COST				
Balance as at 01/01/2015	60,000,000	23,000,000	3,370,564,000	3,453,564,000
Charge for the Year	-	-	-	-
Balance as at 31/12/2015	60,000,000	23,000,000	3,370,564,000	3,453,564,000
DEPRECIATION				
Balance as at 01/01/2015	-	575,000	421,320,500	421,895,500
Charge for the Year	-	2,803,125	368,655,438	371,458,563
Balance as at 31/12/2015	-	3,378,125	789,975,938	793,354,063
NET BOOK VALUE				
Balance as at 31/12/2015	60,000,000	19,621,875	2,580,588,063	2,660,209,938

DESCRIPTION/ASSET CATEGORY	LAND AND BUILDINGS	FURNITURE & FITTINGS	MACHINERY & EQUIPMENT	TOTAL
COST				
Balance as at 01/01/2016	60,000,000	23,000,000	3,370,564,000	3,453,564,000
Additions (Fridge)	-	-	-	-
Balance as at 31/12/2016	60,000,000	23,000,000	3,370,564,000	3,453,564,000
DEPRECIATION				
Balance as at 01/01/2016	-	3,378,125	789,975,938	793,354,063
Charge for the Year	-	2,452,734	322,573,508	325,026,242
Balance as at 31/12/2016	-	5,830,859	1,112,549,445	1,118,380,305
NET BOOK VALUE				
Balance as at 31/12/2016	60,000,000	17,169,141	2,258,014,555	2,335,183,695

DESCRIPTION/ASSET CATEGORY	LAND AND BUILDINGS	FURNITURE & FITTINGS	MACHINERY & EQUIPMENT	TOTAL
COST				
Balance as at 01/01/2017	60,000,000	23,000,000	3,370,564,000	3,453,564,000
Additions			-	-
Balance as at 31/12/2017	60,000,000	23,000,000	3,370,564,000	3,453,564,000
DEPRECIATION				
Balance as at 01/01/2017	-	5,830,859	1,112,549,445	1,118,380,305
Charge for the Year	-	2,146,143	282,251,819	284,397,962
Balance as at 31/12/2017	-	7,977,002	1,394,801,265	1,402,778,267
NET BOOK VALUE				
Balance as at 31/12/2017	60,000,000	15,022,998	1,975,762,735	2,050,785,733

DESCRIPTION/ASSET CATEGORY	LAND AND BUILDINGS	FURNITURE & FITTINGS	MACHINERY & EQUIPMENT	TOTAL
COST				
Balance as at 01/01/2018	60,000,000	23,000,000	3,370,564,000	3,453,564,000
Additions			-	-
Balance as at 31/12/2018	60,000,000	23,000,000	3,370,564,000	3,453,564,000
DEPRECIATION				
Balance as at 01/01/2018	-	7,977,002	1,394,801,265	1,402,778,267
Charge for the Year	-	1,877,875	246,970,342	248,848,217
Balance as at 31/12/2018	-	9,854,877	1,641,771,607	1,651,626,483
NET BOOK VALUE				
Balance as at 31/12/2018	60,000,000	13,145,123	1,728,792,393	1,801,937,517

MATERIALS REQUIRED	SIZE	QTY
PLANT AND STRUCTURE MATERIAL FOR OIL PLANT		
I BEAM	350 MM	15 MTS
I BEAM	300 MM	20MTS
I BEAM	250 MM	30 MTS
I BEAM	200 MM	20 MTS
I BEAM	150 MTS	15 MTS
I BEAM	100 MM	10MTS
MS PLATE	8 MM	110 MTS
MS PLATE	6 MM	160 MTS
MS PLATE	4MM	10 MTS
MS PLATE	3 MM	30 MTS
U CHANNEL	100 MM	35 MTS
U CHANNEL	50 MM	10 MTS
MS ANGLE	50 X50 X 6MM	10MTS
MS ANGLE	50 X40 X6MM	10MTS
MS ANGLE	40 X40 X6MM	15 MTS
MS ANGLE	25 X25 X 4MM	10 MTS
MS PIPES SEEMLESS	2"	3000 METRES
MS PIPES SEEMLESS	1 1/2"	1000 METERS
MS PIPES C CLASS	3"	600 METERS
MS PIPES C CLASS	2"	1500 METERS
MS PIPES C CLASS	1 1/2"	1000 METERS
MS PIPES C CLASS	1"	300 METERS
MS PIPES C CLASS	1/2"	250 METERS
GI PIPE C CLASS	3"	300 METERS
GI PIPE C CLASS	2"	800 METERS
GI PIPE C CLASS	1 1/2"	200 METERS
GI PIPE C CLASS	1"	400 METERS
GI PIPE C CLASS	1/2"	250 METERS
GI BEND 3"	3"	40 NOS
GI BEND 2"	2"	60 NOS
GI BEND 1"	1"	60 NOS
GI BEND 1/2"	1/2"	60 NOS
GI FLANGE	3"	120 NOS
GI FLANGE	2"	160 NOS
GI FLANGE	1 1/2"	160 NOS
GI FLANGE	1"	120 NOS
GI FLANGE	1/2"	100 NOS
GI H NIPPLE 3"	60 NOS	60NOS
GI H NIPPLE 2"	60 NOS	60 NOS
GI H NIPPLE 1"	100 NOS	100 NOS
GI H NIPPLE 1/2 "	60 NOS	60NOS
MS FLANGES 150# RATINGS	3"	260 NOS
MS FLANGES 150# RATINGS	2"	800 NOS
MS FLANGES 150# RATINGS	1 1/2"	760 NOS

MS FLANGES 150# RATINGS	1"	300 NOS
MS FLANGES 4"	40 NOS	40 NOS
MS H NIPPLE 1/2 "	40 NOS	
MS H NIPPLE 1"	100 NOS	
FORGE STEEL VALVES 800#	3"	100 NOS
FORGE STEEL VALVES 800#	2"	240 NOS
FORGE STEEL VALVES 800#	1 1/2"	160 NOS
FORGE STEEL VALVES 800#	1"	70 NOS
MS GATE VALVES	1/2"	
MS GATE VALVES	1"	
MS GATE VALVES	1 1/2"	
MS GATE VALVES	2"	
MS GATE VALVES	3"	
NRV SWING VALVES		30 NOS
GI COUPLING	3"	80 NOS
GI COUPLING	2"	100 NOS
GI COUPLING	1"	100 NOS
GI COUPLING	1/2"	100 NOS
GI ELBOW	3"	
GI ELBOW	2"	
GI ELBOW	1"	
GI ELBOW	1/2"	
MS BUTTERFLY VALVES 1/2	15 NOS	15 NOS
MS BUTTERFLY VALVES 1"	20 NOS	20 NOS
MS BUTTERFLY VALVES 1 1/2	30 NOS	30 NOS
MS BUTTERFLY VALVES 2"	30 NOS	30 NOS
MS BUTTERFLY VALVES 3"	15 NOS	15 NOS
SS BALL VALVE	3"	40 NOS
SS BALL VALVE	2"	60 NOS
SS BALL VALVE	1 1/2"	40 NOS
SS BALL VALVE	1"	40 NOS
SS BALL VALVE	1/2"	40 NOS
MS BOLT	5/8 X4"	100 KGS
MS BOLT	5/8 X3"	100 KGS
MS BOLT	1/2"X2"	180 KGS
MS BOLT	3/8 X 3"	40 KGS
MS BOLT	1/2 X3"	100 KGS
MS NUT	5/8"	65 KGS
MS NUT	1/2"	90 KGS
MS NUT	3/8"	15 KGS
MS BEND	3"	60 NOS
MS BEND	2"	120 NOS
MS BEND	1 1/2"	120 NOS
MS BEND	1"	40 NOS
MS BEND	1/2"	30 NOS
MS ELBOW	3"	60 NOS
MS ELBOW	2"	120 NOS
MS ELBOW	1 1/2"	100 NOS

MS ELBOW	1"	100 NOS
MS REDUCER	3"X2"	60 NOS
MS REDUCER	2" X1 1/2"	80 NOS
MS REDUCER	2"X 1"	40 NOS
MS REDUCER	1"X1/2"	40 NOS
MS WASHER	1/2"	50 KGS
MS WASHER	5/8"	50 KGS
MS WASHERS	3/8"	5 KGS
GI REDUCER	3"X2"	80 NOS
GI REDUCER	3"X1"	30 NOS
GI REDUCER	3"X1/2"	20 NOS
GI REDUCER	2"X 1"	40 NOS
GI REDUCER	2"X1/2"	40 NOS
GI REDUCER	1"X1/2"	60 NOS
GI T BEND	3"X2"	40 NOS
GI T BEND	3"X1"	40 NOS
GI T BEND	2"X 1 1/2"	100 NOS
GI T BEND	2"X1"	80 NOS
GI T BEND	2"X1/2"	60 NOS
GI T BEND	1 1/2"X1"	40 NOS
GI T BEND	1 1/2"X1/2"	40 NOS
GI T BEND	1"X1/2"	80 NOS
Y STRAINER		15 NOS
PIPE NIPPLES		60 NOS
PIPE CLAMS ALL TYPES		245 NOS
BRIDE HOSE (VARIOUS INCHES) – 75 Mtrs		75MTRS
H- NIPPLES (1 1/2", 1" 1/2", 3/8")		120 NOS
REDUCED H – NIPPLES		20 NOS
MS HEX SCREWS		400 KGS
FOUNDATION BOLTS		200 KGS
FLAT VASHERS		80 KGS
MS –SPRING VASHERS		40 KGS
MS PLATE		10 MTRS
MS COUPLING	3/8"	140 NOS
MS STOP CORKE	3/8"	120 NOS
MS SHAFT	6" DIA	80 MTRS
HOSE WITH STEEL IMPREG	3"	120 METERS
HOSE WITH STEEL IMPREG	2"	120 MTRS
HOSE WITH STEEL IMPREG	1"	120 METERS
HYDRULIC HOSE	1/2"	60 MTRS
CLIPS FOR HOSE	1/2"	100 NOS
CHIMNEY PIPE	24" DIA MS	100 MTRS
MS STUD	1"	10 KGS
MS STUD	5/8"	5 KGS
MS STUD	3/8"	3 KGS
NYLON ROPE	50 MTR X3 NOSX 1" THICK	
D CHACKLES	6"	4 NOS
D CHACKLES	10"	2 NOS

M33 MS STUD		35 NOS
ROPE PULLEY	12"	2 NOS
ROPE PULLEY	8"	2 NOS
5/8" FOUNDATION BOLT MS		120 NOS
1/2" FOUNDATION BOLT		80 NOS
3/8 FOUNDATION BOLT		160 NOS

LIST OF TOOLS AND MISC ITEMS

THREADED RODS		
TOOLS		
WELDING MECHINE 3 PHASE		4 NOS
WELDING MECHINE SINGLE PHASE		3 NOS
WELDING ROD 6013 10SWG		90 CASE
WELDING ROD 6013 12SWG		140 CASE
CABLE (METRE		
WHITE GLASS		
DARK GLASS		
GAS CUTTINGSET& ACCESSORIES		
HOSE (METRE)		
GLOVES (SETS)		
CUT OFF MACHINE		
ANGLE GRINDING MACHINE AG7		
ANGLE GRINDING MACHINE AG4		
SCREW JACK		
LIFTING PULLEY		
COIR ROPE (BUNDLE)		
NYLON ROPE (METRE)		
CHAIN PULLEY BLOCK 3 TON 6 MTRS HEIGHT		
CHAIN PULLEY BLOCK 3 TON 8 MTRS HEIGHT		
CHAIN PULLEY BLOCK 5 TON 8 MTRS HEIGHT		
8 MM CHAIN 6 METRE BIT		
D CHACKLES		
SLEDGE HAMMER 14 POUNDS		
HAMMER 8 POUNDS		
HAMMER BALL PAIN		
CHISSLE		
PUNCH		
MEASURING TAPE – 5 Mtr		
12" DIVIDER		
12" TRY SQUARE		
STEEL RULE (12" &24")		
PIPE WRENCH (24" ,12" , 18")		
SCREW SPANNER (10" ,12" ,)		
SPPANER SET		
ALLEGN KEY - SET		

FILES (ROUND, FLAT , 1" & 1/2")		
CHALK PIECE		
EMERY SHEET		
TEFLON TAPES		
HIGH TEMPARATURE CASKET(3MM, 5 MM)		
LOW TEMP, CASKET (3MM, 5MM)		
PRESSURE GAUGE		100 NOS
VACUUM GAUGES		30 NOS
DIGITAL THERMOMETER WITH K TYPE THERMOCOUPLE		100 NOS
ROUND THERMOMETER WITH STEM LENGTH 12"		30 NOS
COTTON WASTE		
WATER TUBE		
PAINTS- RED OXIDE		
ENAMEL PAINTS		
PRIMER		
BRUSH (4" ,3" ,2" , 1")		
MULTI COLOUR MARKERS		
Rounded MS plates &MS Dishes 1400KGSX 6 NOS=8400 KGS(5 KL TANKS)		
20)ROUNDED MS PLATES& MS DISHES - (3400 KGS X9 NOS =30600 KGHS(20 KL)		

ELECTRICAL ITEMS

TOOLS- TESTER		5 NOS
INSULATION TAPE		120 NOS
JUNCTION BOX		50 NOS
PLUG POINT, SWITCHES ,		250 NOS
TUBE LIGHT		200 NOS
SODIUM VAPOUR LAMP		25 NOS
MAINS – 300KVA. 150 KVA		2 NOS
BRACKERS -		50 NOS
L&T STARTER		25 NOS
L&T MAINS		25 NOS
CABLES		
5 ½ INCH CABLE -		100 MTRS
2 ½ INCH CABLE -		250 MTRS
1 1/2 INCH CABLE -		500 MTRS
VOLT METER, AMMETER -		40 NOS
SWITCH GEAR		
PANEL BOARDS/SWITCHES/STARTERS/CABLES		

INSULATION MATERIALS

CERAMIC WOOL 96 DENSITY (BOX)		125 NOS
SS STUD & NUT 5"		350 NOS
SS STUD & NUT 4"		350 NOS
CHICKEN MESH ROLLS		30 NOS
ALUMINUM SHEET - 24 S WG		400 KG
ALUMINUM SHEET - 22SWG -		450 KG
METAL SCREW -8X13		25 BOX
ROCK WELL (ROLL)		350 NOS
GLASS FITTINGS 3"		20 NOS
GLASS FITTINGS 2"		20 NOS
4MM GI WIRE		60 KGS
BINDING WIRE (GI)		40 KGS
MACHINERY FOR PLANT		
Thermopac -600 U - 2 unit		
column(six metre x 600mm -3 unit		
. reaction kettle (15 KL capacity)- 4 nos		
. condenser - 4 nos		
Water cooler -4 nos		
Storage tank(20 kl ms tank) -9 nos		
Filtre press -2 nos		
. vacuum pump -4 nos		
. vacuum pump booster 4 nos		
receiver tank (5 kl ms tank) -8 nos		
11.5hp/7.5pumps and motors -15 nos		
cooling tower 200ltr - 2 nos		
storage tank (100 kl) - 6 nos		
Generator		
15.ms filters -8 nos		
Blending tanks (15 kl) -2 nos		
.Lab equipments(like viscometre, calorimetre, flash cup, colour, pourpoint apparat		
gas cutting machine - 2 nos		
reboilers - 3 nos		
Air compressors - 1 no		
.Gear Motors with 20 HP Motor		
. Chiller 5TR		
Pressure Filter		
Fin Tube Receiver		
Bleaching Tank 15KL		
Chimney 1no 15mtr		
Auto Burner & Electrical Panel		
.Structure for column 21mts		
TBN 400	8200 kgs	
Zinc Booster Additive	2000kgs	
Pour Point Depesant	900kgs	

Hydraulic Oil Additive	1000kgs	
Gear oil Additive	1000kgs	
Additive 9300	3000kgs	
ShamaPrene 8024 Additive	10,000kgs	
ShamaPrene 161	5000kgs	
BASE OIL		

CTIN.: 2212830

ISO 9001 : 2008 Certified



TANZANIA REVENUE AUTHORITY

CERTIFICATE OF REGISTRATION

FOR

TAXPAYER IDENTIFICATION NUMBER (TIN)

(ISSUED UNDER SECTION 133 OF THE INCOME TAX ACT NO. 11 OF 2004)

THIS IS TO CERTIFY THAT

OASIS GREEN TANZANIA LIMITED

has been registered with the Tanzania Revenue Authority and assigned the Taxpayer Identification Number

122-721-256

16-12-2013

with effect from



P. N. Kassera

OFFICIAL SEAL

COMMISSIONER FOR DOMESTIC REVENUE

NOTE: THE REQUIREMENTS UNDER WHICH THIS CERTIFICATE IS ISSUED ARE STATED OVERLEAF

AGREEMENT TO LEASE

This Lease is dated 17th day of December 2013

BETWEEN

ALLIED TRANSPORT AGENT LTD of P.O. BOX 72876 Dar es Salaam
(hereinafter referred to as the "**LESSOR**" of the one part.

AND

OASIS GREEN TANZANIA LTD of P.O. Box 65365 **DAR ES SALAAM** (hereafter referred to as the "**LESSEE**" of other part.

It is agreed as follows:-

1. That the **LESSOR** grants lease part of the property to wit One Thousand square metres at Plot No. 1010 Block "A" Buguruni Area Bonde la Msimbazi Dar es Salaam (hereinafter referred to as the "Property") for lease for a period of 4 years commencing from the 17th day of December 2013 but subject to an option for renewal hereinafter contained and paying therefore unto the Lessor during the said term a monthly rent of **Tanzanian Shillings Five Hundred Thousand** payable **twelve months** in advance. The property shall be free for the '**LESSEE**'s occupation from 17th day of December 2013
2. The **LESSEE** shall have a right to renew the Lease on terms to be negotiated and agreed between the parties.

I Certify that this Document
is a True Copy of the Original

Signature: *N. I. Washokera*

Date: 6/1/2014



3. The **LESSOR** shall pay land rent, other taxes and rates levied on the Property and rent during the Lease period, including stamp duty.
4. The **LESSEE** shall pay all charges for electricity, telephone, water and feed garbage disposal (if any) payable during the tenure of the Lease period.
5. The **LESSEE** shall not carry out any alterations to the Property without a prior written consent of the **LESSOR**.
6. The **LESSEE** shall not sublet or part with possession of the said Property without the prior written consent of the **LESSOR**.
7. That the **LESSEE** will erect a waste oil recycling plant on the said Property
8. The **LESSOR** shall be responsible for ensuring that the any such development on the Property is structurally sound, the roof watertight and the boundary fences maintained in sound and secure condition.
9. The **LESSEE** shall ensure any development on the property is in conformance with relevant laws and fulfills the required industrial standards in the construction industry, environmental sphere and regulatory framework.
10. The **LESSOR** to be responsible for ensuring that the Property is at all the times during the Lease period connected to an adequate

water supply and electricity and that sanitation and drainage on the property are effective and maintained in good condition.

11. The **LESSEE** shall be responsible for care and cleanliness of the Property and shall return the Property to the **LESSOR** in good tenable condition (reasonable wear and tear expected).

12. The **LESSOR** or her servants and agents will at all reasonable times have the right to enter upon the Property for carrying out inspection and any work of repairs, additions or alternations on the Property or to the connections for the amenities aforesaid by giving reasonable notice to the **LESSEE** and the **LESSEE** shall not unreasonably object to the same.

13. The Lease cannot be terminated during the first 24 months and thereafter both parties can terminate the contract by a giving three months' notice.

14. Any disagreement on the interpretation of this Lease shall be settled by accord of the parties. In the absence of agreement, the **LESSOR** and the **LESSEE** shall each appoint an arbitrator who shall appoint a third arbitrator chosen among the local lawyers, public notaries or estate agents. The three of them shall decide on the issue, by majority vote in accordance with the Arbitration Act, Cap 15. The parties shall be bound by this decision.

IN WITNESS WHEREOF the parties hereto have executed these presents in the manner and the date and year herein below appearing:

water supply and electricity and that sanitation and drainage on the property are effective and maintained in good condition.

11. The **LESSEE** shall be responsible for care and cleanliness of the Property and shall return the Property to the **LESSOR** in good tenable condition (reasonable wear and tear expected).

12. The **LESSOR** or her servants and agents will at all reasonable times have the right to enter upon the Property for carrying out inspection and any work of repairs, additions or alternations on the Property or to the connections for the amenities aforesaid by giving reasonable notice to the **LESSEE** and the **LESSEE** shall not unreasonably object to the same.

13. The Lease cannot be terminated during the first 24 months and thereafter both parties can terminate the contract by a giving three months' notice.

14. Any disagreement on the interpretation of this Lease shall be settled by accord of the parties. In the absence of agreement, the **LESSOR** and the **LESSEE** shall each appoint an arbitrator who shall appoint a third arbitrator chosen among the local lawyers, public notaries or estate agents. The three of them shall decide on the issue, by majority vote in accordance with the Arbitration Act, Cap 15. The parties shall be bound by this decision.

IN WITNESS WHEREOF the parties hereto have executed these presents in the manner and the date and year herein below appearing:

SEALED with the COMMON SEAL of the said ALLIED TRANSPORT AGENT LTD and DELIVERED in our presence this 17th day of DECEMBER 2013.



Signature: [Signature]
Name: HASSAN MAHAMOOD AHMED
Postal Address: P.O. Box 72876 DSM
Qualification: DIRECTOR

SIGNED and DELIVERED by the said HASSAN MAHAMOOD AHMED who is introduced to me by ISYU MWAIGOMOLE the latter being known to me personally in my presence this 17th day of DECEMBER 2013

Signature: [Signature]
Name: AWADH MOHAMED
Postal Address: P.O. BOX 90551 DSM
Qualification: ADVOCATE



Signature: [Signature]
Name: FARHIA MAHAMOOD AHMED
Postal Address: P.O. BOX 72876 DSM
Qualification: DIRECTOR

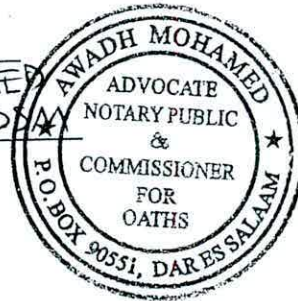

SIGNED and DELIVERED by the said FARHIA MAHAMOOD AHMED who is introduced to me by ISYU MWAIGOMOLE the latter being known to me personally in my presence this 17th day of DECEMBER 2013

Signature: [Signature]
Name: AWADH MOHAMED
Postal Address: P.O. BOX 90551 DSM
Qualification: ADVOCATE

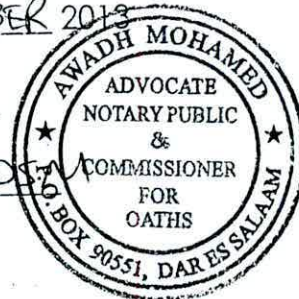

SEALED with the COMMON SEAL of the
said OASIS GREEN TANZANIA LTD
and DELIVERED in our presence
this 17th day of DECEMBER 2013.



Signature: [Signature]
Name: MAHAMOOD AHMED ALI
Postal Address: P.O. Box 65365 DSM
Qualification: DIRECTOR

SIGNED and DELIVERED by the said
MAHAMOOD AHMED ALI who is
introduced to me by ISYU MWAIGOMOLE
the latter being known to me personally in
my presence this 17th day of DECEMBER

Signature: [Signature]
Name: AWADH MOHAMED
Postal Address: P.O. Box 90551 DSM
Qualification: ADVOCATE

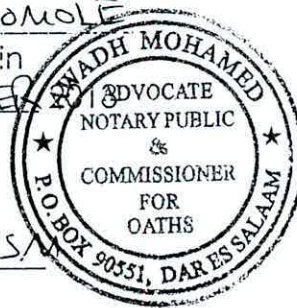

Signature: [Signature]
Name: FAYAZ KHAN
Postal Address: P.O. Box 65365 DSM
Qualification: DIRECTOR

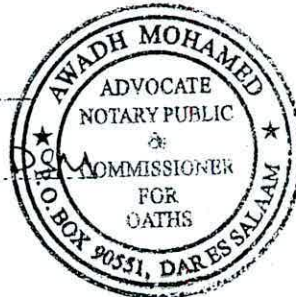

SIGNED and DELIVERED by the said
FAYAZ KHAN who is
introduced to me by ISYU MWAIGOMOLE
the latter being known to me personally in
my presence this 17th day of DECEMBER

Signature: [Signature]
Name: AWADH MOHAMED
Postal Address: P.O. Box 90551 DSM
Qualification: ADVOCATE

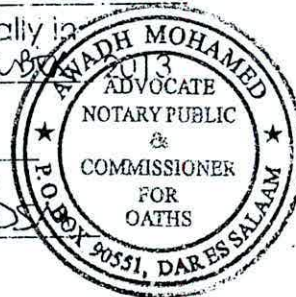

I Certify that this Document
is a True Copy of the Original

Signature: [Signature]
Date: 6/1/2014

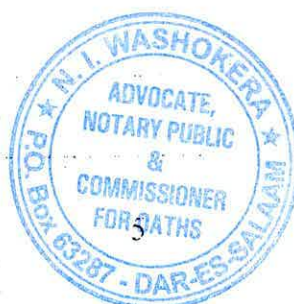

OASIS GREEN TANZANIA LIMITED

P.O. BOX 65365, DAR ES SALAAM

①

Tanzania Investment Centre
DAR ES SALAAM



8th October 2013

Dear Sir/Madam

RE: APPLICATION FOR CERTIFICATE OF INCENTIVES

The above subject refers;

We are writing you in support for application for certificate of incentives from Tanzania Investment Centre.

Our company is well established company deals with refining waste oil into lubricant oil and grease. The main objective of this certificate of incentives is to reduce the cost for an ongoing project to acquire machinery and equipments called processors and refiners; refining waste oil is good for environment, several benefit for recycling oil can be achieved that include the costs for refining waste oil is much less than the cost for refining crude oil. The proposed project needs to install heavy equipments in order for the factory to make production to its high capacity. In additional to that the company has determined to be the first company in Tanzania that refine waste oil to the highest capacity as a local Tanzania company. Due to the above objective the management of the Company is applying for certificate of incentives in order to acquire the working tools.

We believe the proposed certificate will bear positive results against costs for acquisition of equipments and machineries as well as reducing other business operations. We assure you that, we are a credible company and we would like to invest in the oil sector as we have seen a potentiality for business success. To support our application, we submit



- i. Feasibility study and Financial projections for the period of one year
- ii. Certificate of registration
- iii. Memorandum of Association.

It is our hope you will consider our request, should you need any further information, please don't hesitate to contact me at any time.

Yours,

.....

Isyu Adam

For MANAGING DIRECTOR

CTIN.: 2212830

ISO 9001 : 2008 Certified



TANZANIA REVENUE AUTHORITY

CERTIFICATE OF REGISTRATION

FOR

TAXPAYER IDENTIFICATION NUMBER (TIN)

(ISSUED UNDER SECTION 133 OF THE INCOME TAX ACT NO. 11 OF 2004)

THIS IS TO CERTIFY THAT

OASIS GREEN TANZANIA LIMITED

.....

has been registered with the Tanzania Revenue
Authority and assigned the Taxpayer
Identification Number

122-721-256

.....
16-12-2013

with effect from



P. N. Kassera

OFFICIAL SEAL

COMMISSIONER FOR DOMESTIC REVENUE

NOTE: THE REQUIREMENTS UNDER WHICH THIS CERTIFICATE IS ISSUED ARE STATED OVERLEAF



00220549

THE UNITED REPUBLIC OF TANZANIA

16/1/2014
For: Executive Director
Tanzania Investment Centre

Certificate of Incentives

(Section 17 of the Tanzania Investment Act, 1997)

042558

No:

This is to certify that

OASIS GREEN TANZANIA LIMITED

of address P.O. BOX 65365

DAR ES SALAAM

has been granted a Certificate of Incentives to invest in a new, ~~XXXXXXXXXXXXXXX~~
~~XXXXXXXXXX~~ the enterprise known as

OASIS GREEN TANZANIA LIMITED

Which is located at PLOT NO. 1010 BLOCK A, BUGURUNI AREA

BONDE LA MSIMBAZI, ILALA _ DAR ES SALAAM

Further particulars required by Section 17 of the Tanzania Investment Act are set out overleaf.

Executive Director

Tanzania Investment Centre
P.O. Box 938, Dar es Salaam

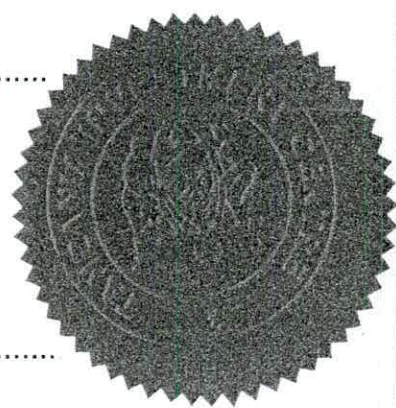

Dated 8TH JANUARY 2014

This Certificate is issued in accordance with the provisions of Section 17 of the Tanzania Investment Act, 1997 and subject to the conditions prescribed under item 14 and 15 hereafter:—

1. Shareholders

	Nationality	Shareholding (%)
Mahamud Ahmed Ali	Tanzanian	25
Fayrouz Khan	Pakistani	20
Abdul Aziz Dakheel Fahad	Saudi arabia	20
Marwan Abouras	Syria	20
Fayaz Khan	Pakistani	15
2. Proposed Activities : **To establish and operate refining waste oil plant**
3. Sector: **Manufacturing** Subsector **Waste Oil**
4. Investment cost: Foreign **USD 2.528m.** Local **-** Total **USD 2.528m.**
5. Project Financing: Equity **USD 2.528m.** Loans **-** Total **USD 2.528m.**
6. Source, terms and conditions of loan.....
7. Assets to be invested:

	Foreign	Local	Total
Capital items:	USD 2.528m.	-	USD 2.528m.
8. Technology Agreement **None**
9. Date of TIC Registration: **19th September 2013**
10. Implementation period **September 2013 - August 2016**
11. Operative date..... **September 2016**
12. Investment Incentive Grade: As defined in part III Section 19 (1), (2) and Section 20 of the Tanzania Investment Act, 1997
 (i) Applicable Import Duty **And VAT as per Customs Tariff Act, 1976 & VAT Act, 1997**
 (ii) Applicable with-holding Tax **As per Income Tax Act, 2004 (as amended)**
 (iii) Eligibility of Capital Allowances **As per Income Tax act, 2004 (as amended)**
13. Protection of Investment, Arbitration and Transfer of Foreign Currency: as defined in part III Section 21, 22 and 23 of the Act.
14. Conditions attached to this Certificate of Incentives
 - (i) Date of Commencement of investment has to be notified to the Centre.
 - (ii) Certificate not to be transferred, assigned or amended
 - (iii) Failure to commence implementation within two years invalidates Certificate
 - (iv) Failure to operate investment must be notified to the Centre
 - (v) Changes in shareholding, project activities and level of invested capital must be notified to the centre
15. Additional conditions attached to Certificate
Finished goods are not allowed under this Certificate

Signed 
Executive Director

TICC/PP.10/042558/3

19th September 2013

Managing Director,
Oasis Green (T) Ltd
P.O. Box 65365
DAR ES SALAAM

RE: CERTIFICATE OF INCENTIVES FOR REFINING WASTE OIL

We wish to acknowledge receipt of your project to establish and operate refining waste oil plant as presented in the TIC P.A. 1 Form No. 11495 and Feasibility Study with a projected investment amounting to USD 2.528m.

We are pleased to inform you that your investment proposal is now officially registered by TIC and therefore the project will be granted a Certificate of Incentives under authority conferred upon TIC under Part III, Section 17 (1-8) of the Tanzania Investment Act, 1997. In order to enable TIC prepare your Certificate of Incentives, You will be required to submit the following:-

- Certified document showing evidence of Land ownership for the location of the project.

Also be informed that you will have to submit a project implementation Progress Report on the implementation of the project in every six months for centre's information and review. Guidelines for the preparation of the report are contained in annexure attached to this letter. Please do not hesitate to contact the Centre for any clarification if the need arises. Also note that a facilitation fee equivalent to US\$ 1000.00 is payable at the ruling exchange rate prior issuance of the Certificate of Incentives. Please make deposit direct to the bank as per bank details below:

.../2

TICC/PP.10/042558/3

19th September 2013

*Tanzania Investment Centre
Standard Chartered Bank (T) Ltd
US Dollar A/C 8702006002000
T.Shs A/C 0102006002000*

We wish you every success in the implementation of the project.

Yours sincerely,
Tanzania Investment Centre



Juliet R. Kairuki
EXECUTIVE DIRECTOR

Copy to: Permanent Secretary,
Ministry of Finance,
P. O. Box 9111,
DAR ES SALAAM

Permanent Secretary,
Ministry of Industry, Trade and Marketing,
P.O. Box 9503,
DAR ES SALAAM

Commissioner General,
Tanzania Revenue Authority,
P. O. Box 11491,
DAR ES SALAAM



TIC Evaluation Report

Name of the Company
Oasis Green (T) Ltd.

Post Box	Msimbazi-Sukita, Plot No. 10/10, Bonde La Mpunga	COI Number	102647	Contact	Isyu Adam
Post Office	65365	COI Date	23/09/2013	Designation	Operation Manager
Region	Dar Es Salaam	Application F. No	11495	Phone	0
Country	Tanzania	Status	New	Direct Phone	0
		Sector	Manufacturing	Cell Phone	0717 156 474
		Sub Sector	waste oil	Fax	0
		File No	042558	E-Mail Address	0

Project Location		Investment Finance Plan in Millions USD			
lot/Block	Plot No. 10/10, Bonde la Mpunga	Foreign Equity	Local Equity	Foreign Loan	Local Loan
Street	Msimbazi-Sukita	2.528	0	0	0
District	Ilala				
Region	Dar es Salaam				

Shareholders Detail			Investment Breakdown (USD Million)	
Name	Nationality	(%)	Land/Building	0.037
Fayaz Khan	Pakistan	15	Plant	1.984
Marwan Abouras	Syrian	20	Vehicles	0.096
Abdul A.D Fahad	Saudi Arabia	20	Furniture & Fittings	0.014
Fayrouz Khan	Pakistan	20	Pre-expenses	0.012
Mahamud A. Alli	Tanzanian	25	Others	0
			Working Capital	0.385
			Total	2.528

Employment	118	Evaluated By	,wf officer4
Capacity	40 litres per day	Drawn By	wf registry2
Project Turn Over		Project Type	Foreign

Description

To establish project for refining waste oil

Recommendations

Be approved subject to providing evidence as required by section 17 of Tanzania Investment Act, 1997

Decision

Approved as recommended
abg
AGED 15/11/2013

Claimed refund beyond three years will be forfeited



A

TANZANIA INVESTMENT CENTRE

Shaaban Robert Street, P.O. Box 938, Dar Es Salaam, Tel. +255 22 2116328-31, Fax: +255 22 2118253

RECEIPT REC013869

No. 007812

Received from : OASIS GREEN (T) LTD

Address P.O. Box 65365 DSM

Received the sum of (In words): ONE THOUSAND AND ZERO CENTS ONLY

Being payment in respect of: CERTIFICATE OF INCENTIVE

Amount : USD 1,000.00

Cash / Cheque No: d/deposit 19/12

Date : 19-Dec-2013



Receiving Officer

TICC/PP.10/042558/6

24/01/2014

Commissioner for Customs & Excise,
Tanzania Revenue Authority,
P.O. Box 9053,
DAR ES SALAAM

Dear Sir,

**RE: DUTY/ VAT REMISSIONS ON CAPITAL/ DEEMED CAPITAL
GOODS – CERTIFICATE OF INCENTIVES No: 042558**

M/S Oasis Green Tanzania Limited is a TIC registered company with certificate of incentives **No. 042558** which is valid up to **August 2016**

The company has been registered with objectives of establishing and operating refining waste oil Plant.

Attached herewith please find a list of Capital/ Deemed Capital Goods for Duty/ VAT remissions approval.

Yours sincerely

TANZANIA INVESTMENT CENTRE

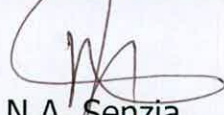

N.A. Senzia

FOR: EXECUTIVE DIRECTOR

OASIS GREEN TANZANIA LIMITED
P.O BOX 65365 DAR ES SALAAM
MOB: +255 754 890 744 / +255 717 156474

5

Commissioner of Customs & Excise
Tanzania Revenue Centre,
P.O. Box 9053
DAR ES SALAAM

January 16, 2014

UFS
Executive Director,
Tanzania Investment Centre,
P.o. Box 938,
DAR ES SALAAM



Dear Sir

RE: DUTY & VAT EXEMPTION ON CAPITAL/DEEMED CAPITAL GOODS FOR CERTIFICATE OF INCENTIVES NO: 042558

We are Tic approved project with certificate of incentives No; 042558 which is valid from September 2013 up to September 2016.

This company has been registered with objectives of establishing and operates refining waste oil plant.

Attached herewith please find a list of Capital/Deemed Capital Goods for Duty/VAT exemption approved.

Yours Sincerely,

Isyu Adam

Isyu Adam
For Managing Director
Oasis Green Tanzania Ltd



OASIS GREEN TANZANIA LIMITED

P.O. BOX 65365 DAR ES SALAAM

MOB: +255 754 890 744 / +255 717 156474

LIST OF MATERIALS FOR EXEMPTION

S.No	Item Name	Unit Measurement	QTY	Item Group
1	I BEAM	350 MM	18 MTS	Plant & Structure Material for oil plant
2	I BEAM	300 MM	24MTS	Plant & Structure Material for oil plant
3	I BEAM	250 MM	34 MTS	Plant & Structure Material for oil plant
4	I BEAM	200 MM	24 MTS	Plant & Structure Material for oil plant
5	I BEAM	150 MTS	19 MTS	Plant & Structure Material for oil plant
6	I BEAM	100 MM	14MTS	Plant & Structure Material for oil plant
7	MS PLATE	8 MM	114 MTS	Plant & Structure Material for oil plant
8	MS PLATE	6 MM	164 MTS	Plant & Structure Material for oil plant
9	MS PLATE	4MM	14 MTS	Plant & Structure Material for oil plant
10	MS PLATE	3 MM	34 MTS	Plant & Structure Material for oil plant
11	U CHANNEL	100 MM	39 MTS	Plant & Structure Material for oil plant
12	U CHANNEL	50 MM	14 MTS	Plant & Structure Material for oil plant
13	MS ANGLE	50 X50 X 6MM	14MTS	Plant & Structure Material for oil plant
14	MS ANGLE	50 X40 X6MM	14MTS	Plant & Structure Material for oil plant
15	MS ANGLE	40 X40 X6MM	19MTS	Plant & Structure Material for oil plant
16	MS ANGLE	25 X25 X 4MM	14 MTS	Plant & Structure Material for oil plant
17	MS PIPES SEEMLESS	2"	3040 METRES	Plant & Structure Material for oil plant
18	MS PIPES SEEMLESS	1 1/2"	1040 METERS	Plant & Structure Material for oil plant
19	MS PIPES C CLASS	3"	640 METERS	Plant & Structure Material for oil plant
20	MS PIPES C CLASS	2"	1540 METERS	Plant & Structure Material for oil plant
21	MS PIPES C CLASS	1 1/2"	1040 METERS	Plant & Structure Material for oil plant
22	MS PIPES C CLASS	1"	340 METERS	Plant & Structure Material for oil plant
23	MS PIPES C CLASS	1/2"	290 METERS	Plant & Structure Material for oil plant
24	GI PIPE C CLASS	3"	340 METERS	Plant & Structure Material for oil plant
25	GI PIPE C CLASS	2"	840 METERS	Plant & Structure Material for oil plant
26	GI PIPE C CLASS	1 1/2"	240 METERS	Plant & Structure Material for oil plant
27	GI PIPE C CLASS	1"	440 METERS	Plant & Structure Material for oil plant
28	GI PIPE C CLASS	1/2"	290 METERS	Plant & Structure Material for oil plant
29	GI BEND 3"	3"	44 NOS	Plant & Structure Material for oil plant

S.No	Item Name	Unit Measurement	QTY	Item Group
30	GI BEND 2"	2"	90 NOS	Plant & Structure Material for oil plant
31	GI BEND 1"	1"	90 NOS	Plant & Structure Material for oil plant
32	GI BEND 1/2"	1/2"	90 NOS	Plant & Structure Material for oil plant
33	GI FLANGE	3"	160 NOS	Plant & Structure Material for oil plant
34	GI FLANGE	2"	190 NOS	Plant & Structure Material for oil plant
35	GI FLANGE	1 1/2"	190 NOS	Plant & Structure Material for oil plant
36	GI FLANGE	1"	160 NOS	Plant & Structure Material for oil plant
37	GI FLANGE	1/2"	140 NOS	Plant & Structure Material for oil plant
38	GI H NIPPLE 3"	60 NOS	90NOS	Plant & Structure Material for oil plant
39	GI H NIPPLE 2"	60 NOS	90 NOS	Plant & Structure Material for oil plant
40	GI H NIPPLE 1"	100 NOS	140 NOS	Plant & Structure Material for oil plant
41	GI H NIPPLE 1/2 "	60 NOS	90NOS	Plant & Structure Material for oil plant
42	MS FLANGES 150# RATINGS	3"	290 NOS	Plant & Structure Material for oil plant
43	MS FLANGES 150# RATINGS	2"	840 NOS	Plant & Structure Material for oil plant
44	MS FLANGES 150# RATINGS	1 1/2"	790 NOS	Plant & Structure Material for oil plant
45	MS FLANGES 150# RATINGS	1"	340 NOS	Plant & Structure Material for oil plant
46	MS FLANGES 4"	40 NOS	90 NOS	Plant & Structure Material for oil plant
47	MS H NIPPLE 1/2 "	40 NOS		Plant & Structure Material for oil plant
48	MS H NIPPLE 1"	100 NOS		Plant & Structure Material for oil plant
49	FORGE STEEL VALVES 800# RATINGS	3"	140 NOS	Plant & Structure Material for oil plant
50	FORGE STEEL VALVES 800# RATINGS	2"	280 NOS	Plant & Structure Material for oil plant
51	FORGE STEEL VALVES 800# RATINGS	1 1/2"	190 NOS	Plant & Structure Material for oil plant
52	FORGE STEEL VALVES 800# RATINGS	1"	120 NOS	Plant & Structure Material for oil plant
53	MS GATE VALVES	1/2"		Plant & Structure Material for oil plant
54	MS GATE VALVES	1"		Plant & Structure Material for oil plant
55	MS GATE VALVES	1 1/2"		Plant & Structure Material for oil plant
56	MS GATE VALVES	2"		Plant & Structure Material for oil plant
57	MS GATE VALVES	3"		Plant & Structure Material for oil plant
58	NRV SWING VALVES		70 NOS	Plant & Structure Material for oil plant
59	GI COUPLING	3"	120 NOS	Plant & Structure Material for oil plant
60	GI COUPLING	2"	140 NOS	Plant & Structure Material for oil plant
61	GI COUPLING	1"	140 NOS	Plant & Structure Material for oil plant

S.No	Item Name	Unit Measurement	QTY	Item Group
62	GI COUPLING	1/2"	140 NOS	Plant & Structure Material for oil plant
63	GI ELBOW	3"		Plant & Structure Material for oil plant
64	GI ELBOW	2"		Plant & Structure Material for oil plant
65	GI ELBOW	1"		Plant & Structure Material for oil plant
66	GI ELBOW	1/2"		Plant & Structure Material for oil plant
67	MS BUTTERFLY VALVES 1/2"	15 NOS	19 NOS	Plant & Structure Material for oil plant
68	MS BUTTERFLY VALVES 1"	20 NOS	60 NOS	Plant & Structure Material for oil plant
69	MS BUTTERFLY VALVES 1 1/2"	30 NOS	70 NOS	Plant & Structure Material for oil plant
70	MS BUTTERFLY VALVES 2"	30 NOS	70 NOS	Plant & Structure Material for oil plant
71	MS BUTTERFLY VALVES 3"	15 NOS	60 NOS	Plant & Structure Material for oil plant
72	SS BALL VALVE	3"	160 NOS	Plant & Structure Material for oil plant
73	SS BALL VALVE	2"	240 NOS	Plant & Structure Material for oil plant
74	SS BALL VALVE	1 1/2"	160 NOS	Plant & Structure Material for oil plant
75	SS BALL VALVE	1"	160 NOS	Plant & Structure Material for oil plant
76	SS BALL VALVE	1/2"	160 NOS	Plant & Structure Material for oil plant
77	MS BOLT	5/8 X4"	400 KGS	Plant & Structure Material for oil plant
78	MS BOLT	5/8 X3"	400 KGS	Plant & Structure Material for oil plant
79	MS BOLT	1/2"X2"	720 KGS	Plant & Structure Material for oil plant
80	MS BOLT	3/8 X 3"	160 KGS	Plant & Structure Material for oil plant
81	MS BOLT	1/2 X3"	400 KGS	Plant & Structure Material for oil plant
82	MS NUT	5/8"	260 KGS	Plant & Structure Material for oil plant
83	MS NUT	1/2"	360 KGS	Plant & Structure Material for oil plant
84	MS NUT	3/8"	60 KGS	Plant & Structure Material for oil plant
85	MS BEND	3"	240 NOS	Plant & Structure Material for oil plant
86	MS BEND	2"	480 NOS	Plant & Structure Material for oil plant
87	MS BEND	1 1/2"	480 NOS	Plant & Structure Material for oil plant
88	MS BEND	1"	160 NOS	Plant & Structure Material for oil plant
89	MS BEND	1/2"	120 NOS	Plant & Structure Material for oil plant
90	MS ELBOW	3"	60 NOS	Plant & Structure Material for oil plant
91	MS ELBOW	2"	120 NOS	Plant & Structure Material for oil plant
92	MS ELBOW	1 1/2"	100 NOS	Plant & Structure Material for oil plant
93	MS ELBOW	1"	100 NOS	Plant & Structure Material for oil plant

S.No	Item Name	Unit Measurement	QTY	Item Group
94	MS REDUCER	3"X2"	240 NOS	Plant & Structure Material for oil plant
95	MS REDUCER	2" X1 1/2"	320 NOS	Plant & Structure Material for oil plant
96	MS REDUCER	2"X 1"	160 NOS	Plant & Structure Material for oil plant
97	MS REDUCER	1"X1/2"	160 NOS	Plant & Structure Material for oil plant
98	MS WASHER	1/2"	200 KGS	Plant & Structure Material for oil plant
99	MS WASHER	5/8"	200 KGS	Plant & Structure Material for oil plant
100	MS WASHERS	3/8"	20 KGS	Plant & Structure Material for oil plant
101	GI REDUCER	3"X2"	320 NOS	Plant & Structure Material for oil plant
102	GI REDUCER	3"X1"	120 NOS	Plant & Structure Material for oil plant
103	GI REDUCER	3"X1/2"	320 NOS	Plant & Structure Material for oil plant
104	GI REDUCER	2"X 1"	160 NOS	Plant & Structure Material for oil plant
105	GI REDUCER	2"X1/2"	160 NOS	Plant & Structure Material for oil plant
106	GI REDUCER	1"X1/2"	240 NOS	Plant & Structure Material for oil plant
107	GI T BEND	3"X2"	160 NOS	Plant & Structure Material for oil plant
108	GI T BEND	3"X1"	160 NOS	Plant & Structure Material for oil plant
109	GI T BEND	2"X 1 1/2"	400 NOS	Plant & Structure Material for oil plant
110	GI T BEND	2"X1"	320 NOS	Plant & Structure Material for oil plant
111	GI T BEND	2"X1/2"	240 NOS	Plant & Structure Material for oil plant
112	GI T BEND	1 1/2"X1"	160 NOS	Plant & Structure Material for oil plant
113	GI T BEND	1 1/2"X1/2"	160 NOS	Plant & Structure Material for oil plant
114	GI T BEND	1"X1/2"	320 NOS	Plant & Structure Material for oil plant
115	Y STRAINER		60 NOS	Plant & Structure Material for oil plant
116	PIPE NIPPLES		280 NOS	Plant & Structure Material for oil plant
117	PIPE CLAMS ALL TYPES		980 NOS	Plant & Structure Material for oil plant
118	BRIDE HOSE (VARIOUS INCHES) – 75 Mtrs		300MTRS	Plant & Structure Material for oil plant
119	H- NIPPLES (1 1/2", 1" 1/2", 3/8")		480 NOS	Plant & Structure Material for oil plant
120	REDUCED H – NIPPLES		80 NOS	Plant & Structure Material for oil plant
121	MS HEX SCREWS		400 KGS	Plant & Structure Material for oil plant
122	FOUNDATION BOLTS		800 KGS	Plant & Structure Material for oil plant
123	FLAT VASHERS		320 KGS	Plant & Structure Material for oil plant
124	MS –SPRING VASHERS		160 KGS	Plant & Structure Material for oil plant
125	MS PLATE		40 MTRS	Plant & Structure Material for oil plant

S.No	Item Name	Unit Measurement	QTY	Item Group
126	MS COUPLING	3/8"	560 NOS	Plant & Structure Material for oil plant
127	MS STOP CORKE	3/8"	480 NOS	Plant & Structure Material for oil plant
128	MS SHAFT	6" DIA	320 MTRS	Plant & Structure Material for oil plant
129	HOSE WITH STEEL IMPREGNATED	3"	480 METERS	Plant & Structure Material for oil plant
130	HOSE WITH STEEL IMPREGNATED	2"	480 MTRS	Plant & Structure Material for oil plant
131	HOSE WITH STEEL IMPREGNATED	1"	480 METERS	Plant & Structure Material for oil plant
132	HYDRULIC HOSE	1/2"	240 MTRS	Plant & Structure Material for oil plant
133	CLIPS FOR HOSE	1/2"	400 NOS	Plant & Structure Material for oil plant
134	CHIMNEY PIPE	24" DIA MS	400 MTRS	Plant & Structure Material for oil plant
135	MS STUD	1"	40 KGS	Plant & Structure Material for oil plant
136	MS STUD	5/8"	20 KGS	Plant & Structure Material for oil plant
137	MS STUD	3/8"	12 KGS	Plant & Structure Material for oil plant
138	NYLON ROPE	50 MTR X3 NOSX 1" THICK		Plant & Structure Material for oil plant
139	D CHACKLES	6"	16 NOS	Plant & Structure Material for oil plant
140	D CHACKLES	10"	8 NOS	Plant & Structure Material for oil plant
141	M33 MS STUD		480 NOS	Plant & Structure Material for oil plant
142	ROPE PULLEY	12"	32 NOS	Plant & Structure Material for oil plant
142	ROPE PULLEY	8"	8 NOS	Plant & Structure Material for oil plant
143	5/8" FOUNTATION BOLT MS		480 NOS	Plant & Structure Material for oil plant
144	1/2" FOUNTATION BOLT		320 NOS	Plant & Structure Material for oil plant
145	3/8 FOUNTATION BOLT		640 NOS	Plant & Structure Material for oil plant
146	THREADED RODS	Nos		Tools & MISC Items
147	TOOLS	Nos		Tools & MISC Items
148	WELDING MECHINE 3 PHASE	Nos	16 NOS	Tools & MISC Items
149	WELDING MECHINE SINGLE PHASE	Nos	12 NOS	Tools & MISC Items
150	WELDING ROD 6013 10SWG	Case	360 CASE	Tools & MISC Items
151	WELDING ROD 6013 12SWG	Case	560 CASE	Tools & MISC Items
152	CABLE (METRE			Tools & MISC Items
153	WHITE GLASS			Tools & MISC Items
154	DARK GLASS			Tools & MISC Items
155	GAS CUTTINGSET& ACCESSORIES			Tools & MISC Items
156	HOSE (METRE)			Tools & MISC Items

S.No	Item Name	Unit Measurement	QTY	Item Group
157	GLOVES (SETS)			Tools & MISC Items
158	CUT OFF MACHINE			Tools & MISC Items
159	ANGLE GRINDING MACHINE AG7			Tools & MISC Items
160	ANGLE GRINDING MACHINE AG4			Tools & MISC Items
161	SCREW JACK			Tools & MISC Items
162	LIFTING PULLEY			Tools & MISC Items
163	COIR ROPE (BUNDLE)			Tools & MISC Items
164	NYLON ROPE (METRE)			Tools & MISC Items
165	CHAIN PULLEY BLOCK 3 TON 6 MTRS HEIGHT			Tools & MISC Items
166	CHAIN PULLEY BLOCK 3 TON 8 MTRS HEIGHT			Tools & MISC Items
167	CHAIN PULLEY BLOCK 5 TON 8 MTRS HEIGHT			Tools & MISC Items
168	8 MM CHAIN 6 METRE BIT			Tools & MISC Items
169	D CHACKLES			Tools & MISC Items
170	SLEDGE HAMMER 14 POUNDS			Tools & MISC Items
171	HAMMER 8 POUNDS			Tools & MISC Items
172	HAMMER BALL PAIN			Tools & MISC Items
173	CHISSLE			Tools & MISC Items
174	PUNCH			Tools & MISC Items
175	MEASURING TAPE - 5 Mtr			Tools & MISC Items
176	12" DIVIDER			Tools & MISC Items
177	12" TRY SQUARE			Tools & MISC Items
178	STEEL RULE (12" & 24")			Tools & MISC Items
179	PIPE WRENCH (24", 12", 18")			Tools & MISC Items
180	SCREW SPANNER (10", 12")			Tools & MISC Items
181	SPANNER SET			Tools & MISC Items
182	ALLEN KEY - SET			Tools & MISC Items
183	FILES (ROUND, FLAT, 1" & 1/2")			Tools & MISC Items
184	CHALK PIECE			Tools & MISC Items
185	EMERY SHEET			Tools & MISC Items
186	TEFLON TAPES			Tools & MISC Items
187	HIGH TEMPERATURE CASKET (3MM, 5MM)			Tools & MISC Items
188	LOW TEMP. CASKET (3MM, 5MM)			Tools & MISC Items

S.No	Item Name	Unit Measurement	QTY	Item Group
189	PRESSURE GAUGE		400 NOS	Tools & MISC Items
190	VACUUM GAUGES		120 NOS	Tools & MISC Items
191	DIGITAL THERMOMETER WITH K TYPE THERMOCOUPLE		400 NOS	Tools & MISC Items
192	ROUND THERMOMETER WITH STEM LENGTH 12"		120 NOS	Tools & MISC Items
193	COTTON WASTE			Tools & MISC Items
194	WATER TUBE			Tools & MISC Items
195	PAINTS- RED OXIDE			Tools & MISC Items
196	ENAMEL PAINTS			Tools & MISC Items
197	PRIMER			Tools & MISC Items
198	BRUSH (4", 3", 2", 1")			Tools & MISC Items
200	MULTI COLOUR MARKERS			Tools & MISC Items
201	Rounded MS plates & MS Dishes			Tools & MISC Items
202	1400KGSX 6 NOS-8400 KGS(5 KL TANKS)			Tools & MISC Items
203	20)ROUNDED MS PLATES& MS DISHES -			Tools & MISC Items
204	(3400 KGS X9 NOS -30600 KGHS(20 KL)			Tools & MISC Items
205	TOOLS- TESTER	Nos	20 NOS	Electrical items
206	INSULATION TAPE	Nos	480 NOS	Electrical items
207	JUNCTION BOX	Nos	200 NOS	Electrical items
208	PLUG POINT, SWITCHES ,	Nos	1000 NOS	Electrical items
209	TUBE LIGHT	Nos	800 NOS	Electrical items
210	SODIUM VAPOUR LAMP	Nos	100 NOS	Electrical items
211	MAINS - 300KVA. 150 KVA	Nos	8 NOS	Electrical items
212	BRACKERS -	Nos	200 NOS	Electrical items
213	L&T STARTER	Nos	100 NOS	Electrical items
214	L&T MAINS	Nos	100 NOS	Electrical items
	<u>CABLES</u>			
215	5 ½ INCH CABLE -	Mtrs	400 MTRS	Electrical items
216	2 ½ INCH CABLE -	Mtrs	1000 MTRS	Electrical items
217	1 1/2 INCH CABLE -	Mtrs	2000 MTRS	Electrical items
218	VOLT METER, AMMETER -	Mtrs	160 NOS	Electrical items
219	SWITCH GEAR	Mtrs		Electrical items
220	PANEL BOARDS/SWITCHES/STARTERS/C	Mtrs		Electrical items

S.No	Item Name	Unit Measurement	QTY	Item Group
221	CERAMIC WOOL 96 DENSITY (BOX)	Nos	500 NOS	Insulation Materials
222	SS STUD & NUT 5"	Nos	1400 NOS	Insulation Materials
223	SS STUD & NUT 4"	Nos	1400 NOS	Insulation Materials
224	CHICKEN MESH ROLLS	Nos	120 NOS	Insulation Materials
225	ALUMINUM SHEET - 24 S WG	Kg	1600 KG	Insulation Materials
226	ALUMINUM SHEET - 22SWG -	Kg	1800 KG	Insulation Materials
227	METAL SCREW -8X13	Box	100 BOX	Insulation Materials
228	ROCK WELL (ROLL)	Nos	1400 NOS	Insulation Materials
229	GLASS FITTINGS 3"	Nos	80 NOS	Insulation Materials
230	GLASS FITTINGS 2"	Nos	80 NOS	Insulation Materials
231	4MM GI WIRE	Kgs	240 KGS	Insulation Materials
232	BINDING WIRE (GI)	Kgs	160 KGS	Insulation Materials
233	Thermopac -600 U	Unit		2 Machinery for Plant
234	column(six metre x 600mm -	Unit		2 Machinery for Plant
235	reaction kettle (15 KL capacity)	Nos		4 Machinery for Plant
236	condenser	Nos		4 Machinery for Plant
237	Water cooler	Nos		4 Machinery for Plant
238	Storage tank(20 kl ms tank)	Nos		9 Machinery for Plant
239	Filtre press	Nos		2 Machinery for Plant
240	vacuum pump	Nos		4 Machinery for Plant
241	vacuum pump booster	Nos		4 Machinery for Plant
242	receiver tank (5 kl ms tank)	Nos		8 Machinery for Plant
243	11.5hp/7.5pumps and motors	Nos		15 Machinery for Plant
244	cooling tower 200ltr	Nos		2 Machinery for Plant
245	storage tank (100 kl)	Nos		6 Machinery for Plant
246	Generator	Nos		Machinery for Plant
247	15.ms filters -8 nos	Nos		8 Filters
248	Blending tanks (15 kl)	Nos		2 Machinery for Plant
249	Lab equipments(like viscometre, calorimetre, flash cup, colour, pourpoint apparatus etc as per ASTM standards)			
250	gas cutting machine - 2 nos	Nos		2 Machinery for Plant
251	reboilers - 3 nos	Nos		3 Machinery for Plant
252	Air compressors - 1 no	Nos		1 Machinery for Plant

S.No	Item Name	Unit Measurement	QTY	Item Group
253	.Gear Motors with 20 HP Motor	Nos		Machinery for Plant
254	.Chiller 5TR	Nos		Machinery for Plant
255	Pressure Filter	Nos		Machinery for Plant
256	Fin Tube Receiver	Nos		Machinery for Plant
257	Bleaching Tank 15KL	Nos		Machinery for Plant
258	Chimney Ino 15mtr	Nos		Machinery for Plant
259	Auto Burner & Electrical Panel	Nos		Machinery for Plant
260	.Structure for column 21mts	Nos		Machinery for Plant
261	Burner Rod	35mm or 25mm	8 Nos	Thermopac Accessories
262	Photo Cell For MA150	Nos	8 Nos	Thermopac Accessories
263	Fuel Pump With Motor	Nos	8 Nos	Thermopac Accessories
264	Electrode Cap	Nos	24 Nos	Thermopac Accessories
265	Nozzle 13.5 60*	Nos	24Nos	Thermopac Accessories
266	Nozzle 15.5 60*	Nos	24 Nos	Thermopac Accessories
267	Circulation Pump With Motor	Nos	4 No	Thermopac Accessories
268	3/8" Metalic High Pr.Hose	1.5 m Length	48 Nos	Thermopac Accessories
269	3/8" Metalic High Pr.Hose	1m Length	48 Nos	Thermopac Accessories
270	1/2" Metalic High Pr.Hose	1m Long	60 Nos	Thermopac Accessories
271	1/2" Stream NRV	Nos	32 Nos	Thermopac Accessories
272	RTD assembly	Nos	32 nos	Thermopac Accessories
273	1/4 inch coppe tube		16 role	Thermopac Accessories
274	1/4 X 1/4 copper tube h nipple	Nos	400 nos	Thermopac Accessories
275	1/4 inch ferrul nut with ferrul	Nos	120 nos	Thermopac Accessories
276	3/8 inch bsb back connection 100	0 to 40 kg	40 nos	Thermopac Accessories
277	H.T. cable	Mtr	200 mtr	Thermopac Accessories
278	100 mm dial bottom connection	0 to 10	40nos	Thermopac Accessories
279	Plug and socket	Nos	16 nos	Thermopac Accessories
280	Hooter	Nos	12nos	Thermopac Accessories
281	Indicater lamp	Nos	Each 40 nos	Thermopac Accessories
282	Temperature controller	Nos	16nos	Thermopac Accessories
283	Sight glasses	50 mm	20nos	Thermopac Accessories

284	½ X ½ inch hydraulic H nipple	Nos	80 nos	Thermopac Accessories
285	½ inch X 3/8 inch hydraulic H	Nos	80 nos	Thermopac Accessories
286	¼ X 3/8 hydraulic H nipple	Nos	80 nos	Thermopac Accessories
287	¼ X ¼ hydraulic H nipple	Nos	80 nos	Thermopac Accessories
288	½ inch MS coupling heavy	Nos	400nos	Thermopac Accessories
289	3/8 inch MS coupling heay	Nos	400 nos	Thermopac Accessories
290	Photo cell button type	Nos	8 nos	Thermopac Accessories
291	2 position element switch	Nos	40 nos	Thermopac Accessories
292	NO element	Nos	60 nos	Thermopac Accessories
293	NC element	Nos	60nos	Thermopac Accessories
294	Oil level switch	Nos	12nos	Thermopac Accessories
295	DE-arator tank	Nos	8 nos	Thermopac Accessories
297	25A contactor	4 pole	8nos	Thermopac Accessories
298	MS 150 I-Beam 4mm	Nos	40 nos	
299	MS 100 channel 4mm thick	Nos	240 nos	Plant & structure material for oil plant
300	MS 1.5 inch flatbar 3mm thick	Nos	200 nos	Plant & structure material for oil plant
301	MS 1 inch pipe 3mm thick	Nos	120 nos	Plant & structure material for oil plant
302	MS 1 inch pipe 4mm thick	Nos	40 nos	Plant & structure material for oil plant
303	6M X 1m aluminium shed sheet 0.4 mm	Nos	2200 nos	Plant & structure material for oil plant
304	Insulation aluminium sheet 0.22 mm thick	Nos	1200kg	Plant & structure material for oil plant
305	Insulation spanch wool (blanket) - 50 mm	Box	320 box	Plant & structure material for oil plant
306	Glass wool	Box	200 box	Plant & structure material for oil plant
307	MS 10 inch pipe 6 mm thick	Nos	4 no.	Plant & structure material for oil plant
308	16mm bolt&nut&washer 7 mm length	Nos	1200nos	Plant & structure material for oil plant
309	Gasket sheet 4mm thick	Nos	20nos	Plant & structure material for oil plant
310	Flange with 2 sides	Nos	60nos	Plant & structure material for oil plant
311	2MM G.I Sheet 2 mm	Nos	40 Nos	Plant & structure material for oil plant
312	10 INCH MS Pipe 6mm x6 m	Nos	8 nos	Plant & structure material for oil plant
313	3 HP Water Pump	Nos	8 Nos	Plant & structure material for oil plant
314	4 Core cable	300 sq.mm	240 mtr	Electrical items
315	4 Core cable	4 sq.mm	2000 mtr	Electrical items
316	4 Core cable	1.5 sq.mm	6000 mtr	Electrical items
317	4 Core cable	10 sq.mm	800 mtr	Electrical items
318	4 Core cable	240 sq.mm	1680 mtr	Electrical items
319	4 Core cable	120 sq.mm	600 mtr	Electrical items

S.No	Item Name	Unit Measurement	QTY	Item Group
320	4 Core cable	25 sq.mm	1200 mtr	Electrical items
321	4 Core cable	35 sq.mm	400 mtr	Electrical items
322	3 core cable	6 sq.mm	4480 mtr	Electrical items
323	Yellow green earth wire	2.5 sq.mm	4480 mtr	Electrical items
324	Yellow green earth wire	6 q.mm	2400 mtr	Electrical items
325	Yellow green earth wire	16 sq.mm	600 mtr	Electrical items
326	Yellow green earth wire	120 q.mm	1600 mtr	Electrical items
327	Yellow green earth wire	2.5 sq.mm	1000 mtr	Electrical items
328	Cable tray	200mm	960 mtr	Electrical items
329	3 Pole 40A MCB	Nos	80 Nos	Electrical items
330	3 Pole 63A MCB	Nos	40 Nos	Electrical items
331	3 Pole 32AMCB	Nos	60 Nos	Electrical items
332	3 Pole 100A MCB	Nos	16 Nos	Electrical items
333	Single Pole 10 MCB	Nos	480 Nos	Electrical items
334	2 Pole RCCB 40A	Nos	100 Nos	Electrical items
335	100 A Breaker	Nos	32 Nos	Electrical items
336	Encloser Box (Size 400x300x200)	Nos	80 Nos	Electrical items
337	Encloser Box (Size 400x600x200)	Nos	24 Nos	Electrical items
338	3 Pole 16A MCB	Nos	40 Nos	Electrical items
	Gland (double Compressing			
339	Size 02 (20mm)large	Nos	800 Nos	Electrical items
	(double Compressing gland With cover)			Electrical items
340	Size 01 (16mm)	Nos	240 Nos	Electrical items
341	Size 010 (240 sq.mm with 4 Core)		64 Nos	Electrical items
342	Size 08 (4 Core 120 Sq.mm)	Nos	80 Nos	Electrical items
343	Size 011 (4 Core 300 Sq.mm)		64 Nos	Electrical items
	Copper Legs			Electrical items
344	300 Sq.mm Copper Leg	Nos	200 Nos	Electrical items
345	240 Sq.mm Copper Leg	Nos	200 Nos	Electrical items
346	120 Sq.mm Copper Leg	Nos	200 Nos	Electrical items
347	(25x8 mm) Copper Leg	Nos	400 Nos	Electrical items
348	(35x8 mm) Copper Leg	Nos	200 Nos	Electrical items
349	(6x6 mm) Copper Leg	Nos	800 Nos	Electrical items
350	(4x6 mm) Copper Leg	Nos	800 Nos	Electrical items

351	G.I Bolt Nut With Washer (size 10x50mm)	Nos	1200 Nos	Electrical items
352	G.I Bolt Nut With Washer (size 8x25mm)	Nos	1200 Nos	Electrical items
353	G.I Bolt Nut With Washer (size 6x25mm)	Nos	1200 Nos	Electrical items
354	Electrical Warning Tape (yellow & Black)	Nos	20 Roll	Electrical items
355	Copper Rod (12mmx1m)	Nos	60 Nos	Electrical items
356	G.I Pipe 3"	Nos	4 Length	Electrical items
357	1"x1/4" (3 mm Thick) Copper Flat	Nos	40 Mts	Electrical items
358	Lightning Arrester	Nos	4 Set	Electrical items
359	Porcelaine Insulator	Nos	100 Nos	Electrical items
	Lighting			
340	3 Core 1.5 Sq.mm Flexible Cable	Nos	2000 Mts	Electrical items
341	500W Hologen (IP-65)	Nos	200 Nos	Electrical items
342	500W Sodium Vapour	Nos	24 Nos	Electrical items
343	36W Tube Light Fittings	Nos	400 Nos	Electrical items
344	25W CFL With Holder	Nos	200 Nos	Electrical items
345	Crimping Paste	Nos	40 Pocket	Electrical items
346	Insulation Tape (All Colours)	Nos		Electrical items
347	Clamp Meter	Nos	8 No	Electrical items
348	Electrical Tool Set	Nos	4 No	Electrical items
349	Nut Driver set	Nos	4 No	Electrical items
350	Mini Hack Saw Frame With Blade	Nos		Electrical items
351	Small Knife	Nos		Electrical items
352	MCP Rail	Nos	24 Mts.	Electrical items
353	900 Cable Tray	Nos	12 Mts.	Electrical items
354	G.I Pipe A Class 1/2"	Nos	800 Length	Electrical items
355	1"Bender With Die Set	Nos	4 No	Electrical items
356	1" Two way G.I Junction	Nos	600 Nos	Electrical items
357	1" One Way G.I Junction	Nos	200 Nos	Electrical items
358	1" Three Way G.I Junction	Nos	100 Nos	Electrical items
359	Ball Socket With Check Nut	Nos	800 Nos	Electrical items
360	1" Heavy C.T Clamp	Nos	2000 Nos	Electrical items
361	200mm Cable Tray Joint Plate	Nos	160 Nos	Electrical items
362	200mm Cable Tray Bend	Nos	40 Nos	Electrical items
363	100mm Cable Tray	Nos	72 Mts	Electrical items
364	100mm Cable Tray Joint Plate	Nos	80 Nos	Electrical items
365	100mm Cable Tray Bend	Nos	40 Nos	Electrical items
366	6mm G.I Bolt Nut With Washer	Nos	1200 Nos	Electrical items
367	PVC Pipe 2"	Nos	80 Length	Electrical items
368	PVC Pipe 1"	Nos	40 Length	Electrical items
369	PVC 2" Bend	Nos	80 Nos	Electrical items
370	PVC 1" Bend	Nos	80 Nos	Electrical items
371	3 Phase Welding Jacket With Box	Nos	24 Nos	Electrical items
372	40AMPS RCCB	Nos	24 Nos	Electrical items

S.No	Item Name	Unit Measurement	QTY	Item Group
373	On Off Push Button With Box(NO,NC Element Push Button)	Nos	120 Nos	Electrical items
374	Teplon tape	Nos	200 nos	Electrical items
375	Shelak	Nos	96 nos	Electrical items
376	Cotton thread ball	Nos	2 kg	Electrical items
377	Burner Rod	35mm or 25mm	8 Nos	Machinery & Thermopac Accessories
378	Photo Coll For MA150	Nos	8 Nos	Machinery & Thermopac Accessories
379	Fuel pump With Motor	Nos	8 Nos	Machinery & Thermopac Accessories
380	Electrode Cap	Nos	24 Nos	Machinery & Thermopac Accessories
381	Nozzle 13.5 60*	Nos	24 Nos	Machinery & Thermopac Accessories
382	Nozzle 13.5 60*	Nos	24 Nos	Machinery & Thermopac Accessories
383	Circulation Pump with Motor	Nos	4 No	Machinery & Thermopac Accessories
384	3/8* Metallic High Pr.Hose	1.5 m Length	48 Nos	Machinery & Thermopac Accessories
385	3/8* Metallic High Pr.Hose	1 m length	48 Nos	Machinery & Thermopac Accessories
386	1/2* Metallic High pr.Hose	1 m Long	60 Nos	Machinery & Thermopac Accessories
387	1/2* Steam NRV	Nos	32 Nos	Machinery & Thermopac Accessories
388	RTD assembly	Nos	32 Nos	Machinery & Thermopac Accessories
389	1/4 Inch Coppe Tube	Nos	4 role	Machinery & Thermopac Accessories
390	1/4 x 1/4 Copper tube h nipple	Nos	100 Nos	Machinery & Thermopac Accessories
391	1/4 Inch ferrul nut with ferrul	Nos	120 Nos	Machinery & Thermopac Accessories
392	3/8 inch bsb back connection 100 mm dial	0 to 40 kg	40 Nos	Machinery & Thermopac Accessories
393	H.T cable	Mm	200 Meter	Machinery & Thermopac Accessories
394	100 mm dial bottom connection press gauge	0 to 10	40 Nos	Machinery & Thermopac Accessories
395	Plug and Socket	Nos	16 Nos	Machinery & Thermopac Accessories
396	Used oil storage tank 140 kl 4 dia (Mtr) 12 l	Nos		8 Machinery for plant
397	Fuel oil storage tank 140 kl 4 dia 12 l	Nos		8 Machinery for plant
398	DHO Kettle for used oil- 21 kl, 2 dia, 7 le	Nos		8 Machinery for plant
399	DHO Kettle for fuel oil- 21 kl, 2 dia, 7 len	Nos		8 Machinery for plant
400	Reaction kettle- 21 kl, 2 dia, 7 len	Nos		8 Machinery for plant
401	VI kettle- 21 kl, 2 dia, 7 len	Nos		4 Machinery for plant
402	Blending kettle- 21 kl, 2 dia, 7 len	Nos		4 Machinery for plant
403	Blending kettle- 9 kl, 2 dia, 3 len	Nos		4 Machinery for plant
404	Spare tank- 21 kl, 2 dia, 7 len	Nos		4 Machinery for plant
405	DHO storage tank-38 kl, 3 dia, 5.5 len	Nos		8 Machinery for plant
406	Distillation kettle- 18 kl, 2 dia, 5.5 len	Nos		8 Machinery for plant
407	Receiver tank-8 kl, 2 dia, 2.5 len	Nos		32 Machinery for plant
408	Intermediate storage tank-50 kl, 3 dia, 7 len	Nos		16 Machinery for plant
409	Base oil storage tank-140 kl, 4 dia, 12 len	Nos		4 Machinery for plant
410	Base oil storage tank-50 kl, 3 dia, 7 len	Nos		8 Machinery for plant
411	VI storage tank-21 kl, 3 dia, 3 len	Nos		4 Machinery for plant
412	Distillate storage tank-21 kl, 3 dia, 3 len	Nos		412 Machinery for plant
413	Final product storage tank-50 kl, 3 dia, 7 len	Nos		12 Machinery for plant
414	Water Receive tank-7 kl, 1.75 dia, 3 len	Nos		24 Machinery for plant
415	Base oil	MT	3000 MT	Lubricant Oil
416	Additive	MT	240 MT	Additive
417	Polymers	MT	80 MT	Polymers

S.No	Item Name	Unit Measurement	QTY	Item Group
418	Tanks	40 Nos	Nos	
419	TBN 400	Kgs	6500 Kg	Additives
420	Zinc Booster Additive	Kgs	1600 Kg	Additives
421	Pour Point Depresant	Kgs	720 Kg	Additives
422	Hydraulic Oil Additive	Kgs	800 Kg	Additives
423	Gear oil Additive	Kgs	800 Kg	Additives
424	Additive 9300	Kgs	2400 Kg	Additives
425	ShamaPrene 8024 Additive	Kgs	8000 Kg	Additives
426	ShamaPrene 161	Kgs	4000 kg	Polymers
427	Motors & others			

428	Alkyd Resins	MT	20 MT	Resins
429	Organic Pigment	MT	20 MT	Paint Pigments
430	Titanium Dioxide Pigments	MT	20 MT	Paint Pigments
431	Paint Drier Chemicals	MT	4 MT	Paint Pigments
432	Antiskinning Agent	MT	2 MT	Paint Pigments
433	Dispersing Agent	MT	2 MT	Paint Pigments
434	Biocides	MT	2 MT	Paint Pigments
435	Extender Pigments	MT	58 MT	Paint Pigments
436	Vinyl Resins	MT	40 MT	Paint Pigments
437	Packing Materials	MT	12 MT	Paint Pigments

438	Cranes	Nos	4 Nos	vehicle
439	Forklift	Nos	12 Nos	Vehicle
440	Trucks	Nos	10 Nos	Vehicle
441	Pick Up	Nos	8 Nos	Vehicle
442	Furnitures	Nos	50 Nos	Furniture
443	Hilux	Nos	2 Nos	Vehicle



00220549

THE UNITED REPUBLIC OF TANZANIA

Certificate of Incentives

(Section 17 of the Tanzania Investment Act, 1997)

042558

No:

This is to certify that

.....
OASIS GREEN TANZANIA LIMITED
.....

of address
P.O. BOX 65365

DAR ES SALAAM
.....

has been granted a Certificate of Incentives to invest in a new, ~~new/expanded/expanded~~
~~XXXXXX~~ enterprise known as

OASIS GREEN TANZANIA LIMITED
.....

Which is located at
PLOT NO. 1010 BLOCK A, BUGURUNI AREA

BONDE LA MSIMBAZI, ILALA _ DAR ES SALAAM
.....

Further particulars required by Section 17 of the Tanzania Investment Act are set out overleaf.

.....

Executive Director

Tanzania Investment Centre
P.O. Box 938, Dar es Salaam

Dated 8TH JANUARY 2014

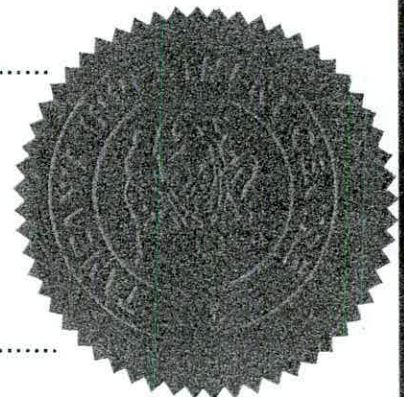

This Certificate is issued in accordance with the provisions of Section 17 of the Tanzania Investment Act, 1997 and subject to the conditions prescribed under item 14 and 15 hereafter:—

1. Shareholders

Shareholders	Nationality	Shareholding (%)
Mahamud Ahmed Ali	Tanzanian	25
Fayrouz Khan	Pakistani	20
Abdul Aziz Dakheel Fahad	Saudi arabia	20
Marwan Abouras	Syria	20
Fayaz Khan	Pakistani	15
2. Proposed Activities : **To establish and operate refining waste oil plant**
3. Sector: **Manufacturing** Subsector **Waste Oil**
4. Investment cost: Foreign **USD 2.528m.** Local **-** Total **USD 2.528m.**
5. Project Financing: Equity **USD 2.528m.** Loans **-** Total **USD 2.528m.**
6. Source, terms and conditions of loan.....
7. Assets to be invested:

Capital items:	Foreign	Local	Total
	USD 2.528m.	-	USD 2.528m.
8. Technology Agreement **None**
9. Date of TIC Registration: **19th September 2013**
10. Implementation period **September 2013 - August 2016**
11. Operative date..... **September 2016**
12. Investment Incentive Grade: As defined in part III Section 19 (1), (2) and Section 20 of the Tanzania Investment Act, 1997
 (i) Applicable Import Duty **And VAT as per Customs Tariff Act, 1976 & VAT Act, 1997**
 (ii) Applicable with-holding Tax **As per Income Tax Act, 2004 (as amended)**
 (iii) Eligibility of Capital Allowances **As per Income Tax act, 2004 (as amended)**
13. Protection of Investment, Arbitration and Transfer of Foreign Currency: as defined in part III Section 21, 22 and 23 of the Act.
14. Conditions attached to this Certificate of Incentives
 - (i) Date of Commencement of investment has to be notified to the Centre.
 - (ii) Certificate not to be transferred, assigned or amended
 - (iii) Failure to commence implementation within two years invalidates Certificate
 - (iv) Failure to operate investment must be notified to the Centre
 - (v) Changes in shareholding, project activities and level of invested capital must be notified to the centre
15. Additional conditions attached to Certificate
Finished goods are not allowed under this Certificate

Signed 
Executive Director